

## TAP-N-GO TRIMMER HEAD 270001

Double line, for cutting and thinning. The nylon line is fed by tapping the cutting head on the ground. Comes standard on many trimmers. Adaptor bolts available to fit most of brush cutter, and detail is following:

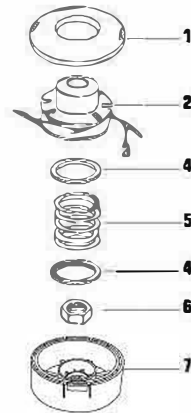

### Spare parts

1	5070101	Upper cover
2	5070102	Spool without line
3	5070103	Line retainer
4	5070104	Plate
5	5070105	Spring
6	5070106	Adaptor M 8x1.25 Left female
	5070107	Adaptor M 8x1.25 Left male
	5070108	Adaptor M 10x1.25 Left female
	5070109	Adaptor M 10x1.25 Left male
	5070110	Adaptor M 10x1.50 Left male
	5070111	Adaptor M 12x1.50 Left female
	5070112	Adaptor M 12x1.75 Left female
7	5070113	Housing

STANDARD PACKING: SLEEVE  
Q.TY PER CARTON: 40 PIECES

## MANUAL TRIMMER HEAD 270002

Manual feed nylon head with lower profile is particularly suitable for trimming low-growing grass around solid obstacles. Complete trimmer head system includes an assortment of number-coded adapter bolts, available adapter bolts to fit most brands and models, detail as below:

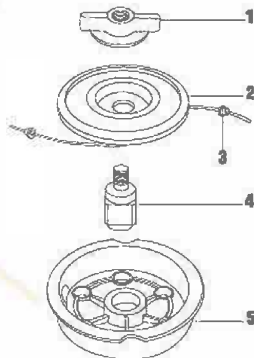

### Spare parts

1	5070201	left aluminium screw
2	5070202	Upper cover
3	5070203	Line retainer
4	5070204	Adaptor M 8x1.25 Left female
	5070205	Adaptor M 8x1.25 Left male
	5070208	Adaptor M 10x1.25 Left female
	5070219	Adaptor M 10x1.25 Left male
	5070210	Adaptor M 10x1.50 Left male
	5070211	Adaptor M 12x1.50 Left female
	5070212	Adaptor M 12x1.75 Left female
5	5070214	Housing

STANDARD PACKING: SLEEVE  
Q.TY PER CARTON: 80 PIECES

## TAP-N-GO TRIMMER HEAD 270003

Popular, Semi-automatic ("Tap-n-go") Dual-line head, durable head, simple tab-lock "push and twist" design allows fast and easy reloading. Available adaptor bolts to fit most brands and models, detail as below:

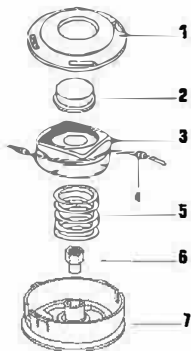

### Spare parts

1	5070301	Upper cover
2	5070302	Top cover
3	5070303	Spool without line
4	5070304	Line retainer
5	5070305	Spring
6	5070306	Adaptor M 8x1.25 Left female
	5070307	Adaptor M 8x1.25 Left male
	5070310	Adaptor M 10x1.25 Left female
	5070311	Adaptor M 10x1.25 Left male
	5070312	Adaptor M 10x1.50 Left male
	5070313	Adaptor M 12x1.50 Left female
	5070314	Adaptor M 12x1.75 Left female
7	5070316	Housing

STANDARD PACKING: SLEEVE  
Q.TY PER CARTON: 40 PIECES

## TAP-N-GO TRIMMER HEAD 270004

Popular, Semi-automatic ("Tap-n-go") Dual-line head, fits universal curved shaft brush cutter:



### Mini

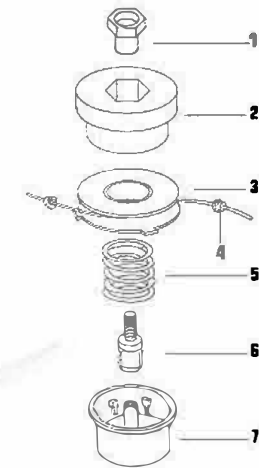

### Spare parts

1	5070401	Screw
2	5070402	Upper cover
3	5070403	Spool without line
4	5070404	Line retainer
5	5070405	Spring
6	5070406	Adaptor M 8x1.25 Left female
	5070407	Adaptor M 8x1.25 Left male
	5070408	Adaptor M 8x1.25 Right female
7	5070409	Housing

STANDARD PACKING: SLEEVE  
Q.TY PER CARTON: 75 PIECES

## EASY Load TAP-N-GO TRIMMER HEAD 270005

Popular, Semi-automatic ("Tap-n-go") Dual-line head, fits universal curved shaft brush cutter:



### Mini

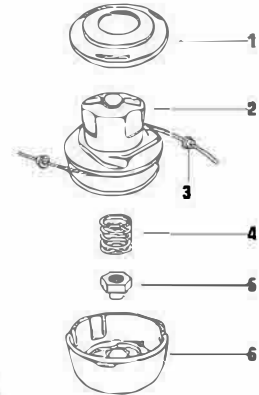

### Spare parts

1	5072401	Upper cover
2	5072402	Spool with line
3	5072403	Line retainer
4	5072404	Spring
5	5072405	Adaptor M 8x1.25 Left female
6	5072406	Adaptor M 8x1.25 Left male
	5072407	Adaptor M 8x1.25 Right female
	5072409	Housing

STANDARD PACKING: SLEEVE  
Q.TY PER CARTON: 75 PIECES



### NEW

## MANUAL TRIMMER HEAD 270006

Double line nylon head Ø 109 mm complete with adaptor bolt - Ø 2.4 mm nylon line.



### Mini

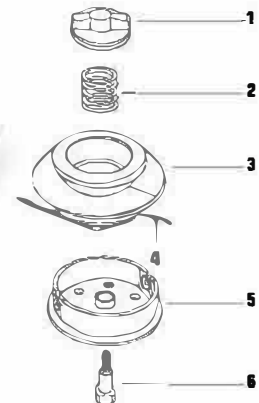

### Spare parts

1	5070501	Knob (Line knob or Triangle knob)
2	5070502	Spring
3	5070503	Spool without line
4	5070504	Line retainer
5	5070505	Housing
6	5070506	Drive Bolt
	5070507	Adaptor M 7x1.00 Left male
	5070508	Adaptor M 8x1.25 Left male
	5070509	Adaptor M 8x1.25 Left female
	5070510	Adaptor M 10x1.00 Left female (fits ST only)
	5070511	Adaptor M 10x1.25 Left female
	5070512	Adaptor M 10x1.25 Left male
	5070513	Adaptor M 10x1.50 Left male
	5070514	Adaptor M 12x1.50 Left female
	5070515	Adaptor M 12x1.75 Left female

STANDARD PACKING: SLEEVE  
Q.TY PER CARTON: 40 PIECES

LINE KNOB TRIANGLE KNOB

## EASYLoad MANUAL TRIMMER HEAD

Double line nylon head Ø 109 mm complete with adaptor bolt - Ø 2.4 mm nylon line.

**270007**



### HIGHLIGHTS

Easy line refilling without disassembling any part of the trimmer head.



Two arrows in one line. Inserts line through eyelet. Turn the knob.

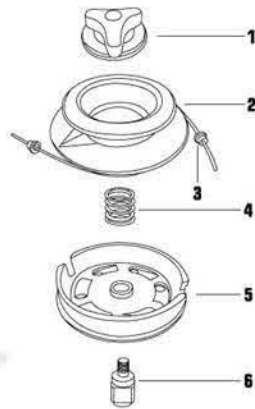

#### Spare parts

1	5072501	Triangle knob
2	5072502	Spool without line
3	5072503	Line retainer
4	5072504	Spring
5	5072505	Housing
6	5072506	Drive Bolt
	5072507	Adaptor M 7x1.00 Left male
	5072508	Adaptor M 8x1.25 Left male
	5072509	Adaptor M 8x1.25 Left female
	5072510	Adaptor M 10x1.00 Left female (fits ST only)
	5072511	Adaptor M 10x1.25 Left female
	5072512	Adaptor M 10x1.25 Left male
	5072513	Adaptor M 10x1.50 Left male
	5072514	Adaptor M 12x1.50 Left female
	5072515	Adaptor M 12x1.75 Left female
		STANDARD PACKING: SLEEVE
		Q.TY PER CARTON: 40 PIECES

**NEW**

## HEAVY DUTY TAP-N-GO TRIMMER HEAD

**270008**

New heavy-duty, semi-automatic Ø 130 mm, M10x1.25 or M8.0x1.25 left-hand male or female shaft thread, with Ø 2.40 or Ø 3.00 mm line. Suitable for Trimmer/Brushcutters up to 51cc. Specific adaptor bolt included. Adaptor bolts available to fit most brands and models

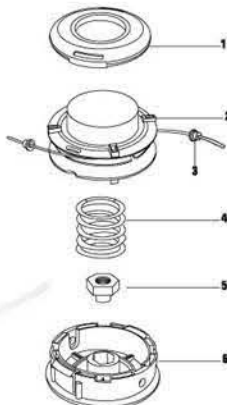

#### Spare parts

1	5070601	Upper cover
2	5070602	Spool without line
3	5070603	Line retainer
4	5070604	Spring
5	5070605	Adaptor M 8x1.25 Left male (fits EMAK only)
	5070606	Adaptor M 8x1.25 Left female
	5070607	Adaptor M 8x1.25 Left male
	5070608	Adaptor M 10x1.00 Left female (fits ST only)
	5070609	Adaptor M 10x1.25 Left female
	5070610	Adaptor M 10x1.25 Left male
	5070611	Adaptor M 10x1.50 Left male
	5070612	Adaptor M 12x1.50 Left female
	5070613	Adaptor M 12x1.75 Left female
6	5070615	Housing
		STANDARD PACKING: SLEEVE
		Q.TY PER CARTON: 40 PIECES

## HEAVY DUTY TAP-N-GO TRIMMER HEAD

**270009**

New heavy-duty, semi-automatic Ø 130 mm, M10x1.25 or M8.0x1.25 left-hand male or female shaft thread, with Ø 2.40 or Ø 3.00 mm line. Suitable for Trimmer/Brushcutters up to 51cc. Specific adaptor bolt included. Adaptor bolts available to fit most brands and models

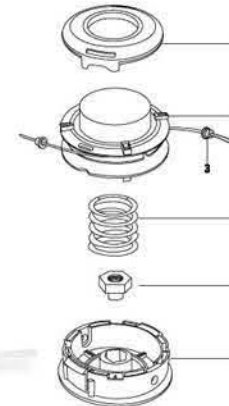

#### Spare parts

1	50712001	Upper cover
2	50712002	Spool without line
3	50712003	Line retainer
4	50712004	Spring
5	50712005	Adaptor M 8x1.25 Left male (fits EMAK only)
	50712006	Adaptor M 8x1.25 Left female
	50712008	Adaptor M 8x1.25 Left male
	50712009	Adaptor M 10x1.00 Left female (fits ST only)
	50712010	Adaptor M 10x1.25 Left female
	50712011	Adaptor M 10x1.25 Left male
	50712012	Adaptor M 10x1.50 Left male
	50712013	Adaptor M 12x1.50 Left female
	50712014	Adaptor M 12x1.75 Left female
6	50712015	Housing
		STANDARD PACKING: SLEEVE
		Q.TY PER CARTON: 40 PIECES

## UNIVERSAL TAP-N-GO TRIMMER HEAD

**270010**

Semi-automatic head "pro universal", Tap-n-go double line head, universal mounting without adaptor, Line spool with zinc plated still insert. Extreme wear resistance. Spool can load 6 meters of round nylon line Ø 2.4mm for professional users.

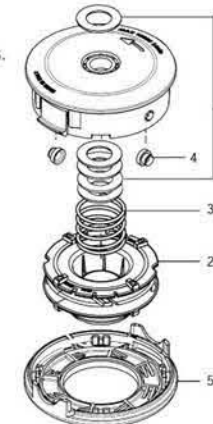
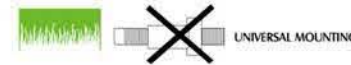

#### Spare parts

1	5070701	Kit of adaptor washers and reduction rings
2	5070702	Spool without line
3	5070703	Spring
4	5070704	Line retainer
5	5070705	Lower cover
		STANDARD PACKING: SLEEVE
		Q.TY PER CARTON: 40 PIECES

## UNIVERSAL TAP-N-GO TRIMMER HEAD

**270011**

Semi-automatic head "pro universal", Tap-n-go double line head, universal mounting without adaptor, Line spool with zinc plated still insert. Extreme wear resistance. Spool can load 6 meters of round nylon line Ø 2.4mm for professional users.

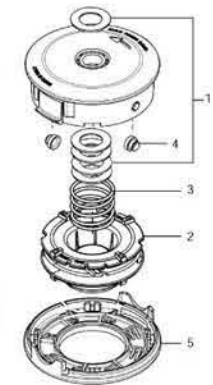
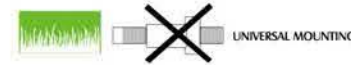

#### Spare parts

1	50712017	Kit of adaptor washers and reduction rings
2	50712018	Spool without line
3	50712019	Spring
4	50712020	Line retainer
5	50712021	Lower cover
		STANDARD PACKING: SLEEVE
		Q.TY PER CARTON: 40 PIECES

## TAP-N-GO TRIMMER HEAD 270012

Double line, for cutting and thinning. The nylon line is fed by tapping the cutting head on the ground. Comes standard on many trimmers. Adaptor bolts available to fit most of brush cutter, and detail is following:

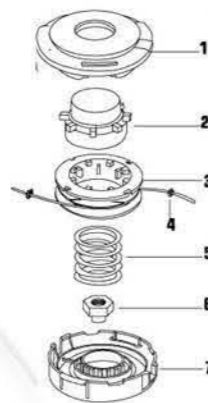

### Spare parts

1	5070801	Upper cover
2	5070802	Top cover
3	5070803	Spool without line
4	5070804	Line retainer
5	5070805	Spring
6	5070806	Adaptor M 8x1.25 Left male (fits EFCO only)
	5070807	Adaptor M 8x1.25 Left male
	5070808	Adaptor M 8x1.25 Right male
	5070809	Adaptor M 10x1.00 Left female (fits ST only)
	5070810	Adaptor M 10x1.25 Left female
	5070811	Adaptor M 10x1.25 Left female (fits HU only)
	5070812	Adaptor M 10x1.25 Left male
	5070813	Adaptor M 10x1.50 Left male (fits MC only)
	5070814	Adaptor M 10x1.50 Left female (fits HU only)
	5070815	Adaptor M 12x1.50 Left female
	5070816	Adaptor M 12x1.75 Left female (fits HU only)
7	5070817	Under cover

STANDARD PACKING: SLEEVE  
Q.TY PER CARTON: 56 PIECES



## TAP-N-GO TRIMMER HEAD 270015

Heavy-duty, tap-d-go string trimmer head. A metal insert in the nylon tap knob extends the head's life by reducing wear and abrasion to the nylon. The tap knob also has a "stay-on" spring, so users never have to crawl around in the grass looking for a spring that popped out. Two split spools make refilling easy and reduce the chance of twining or welding. The eyelet through which the line is threaded is made of aluminum for longer life, and it is replaceable for easy servicing and lower operating costs.

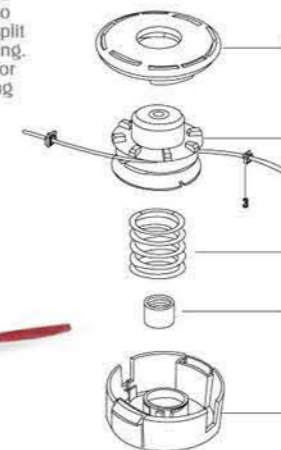

### Spare parts

1	5080211	Upper cover
2	5080212	Spool without line
3	5080213	Line retainer
4	5080214	Spring
	5080215	Adaptor M 8x1.25 Left female
	5080216	Adaptor M 8x1.25 Left male
	5080217	Adaptor M 10x1.00 Left female (fits ST only)
	5080218	Adaptor M 10x1.25 Left female
	5080219	Adaptor M 10x1.25 Left male
	5080220	Adaptor M 10x1.50 Left male (fits MC only)
	5080221	Adaptor M 10x1.50 Left female (fits HU only)
	5080222	Adaptor M 12x1.50 Left female
	5080223	Adaptor M 12x1.75 Left female (fits HU only)
6	5080225	Housing

STANDARD PACKING: SLEEVE  
Q.TY PER CARTON: 40 PIECES

## STIHL 25-2 TAP-N-GO TRIMMER HEAD 270013

Double line, for cutting and thinning. The nylon line is fed by tapping the cutting head on the ground. Comes standard on many trimmers. Adaptor bolts available to fit most of brush cutter, and detail is following:

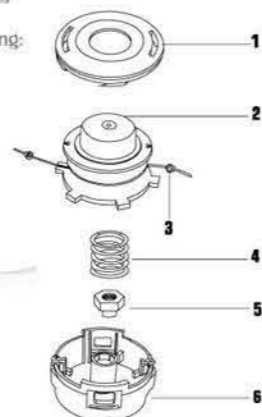

### Spare parts

1	5070901	Upper cover
2	5070902	Spool without line
3	5070903	Line retainer
4	5070904	Spring
5	5070905	Adaptor M 10x1.00 Left female (fits ST only)
	5070906	Adaptor M 10x1.25 Left female
6	5070907	Housing

STANDARD PACKING: SLEEVE  
Q.TY PER CARTON: 40 PIECES

## TAP-N-GO TRIMMER HEAD 270016

Double line, for cutting and thinning. The nylon line is fed by tapping the cutting head on the ground. Comes standard on many trimmers. Adaptor bolts available to fit most of brush cutter, and detail is following:

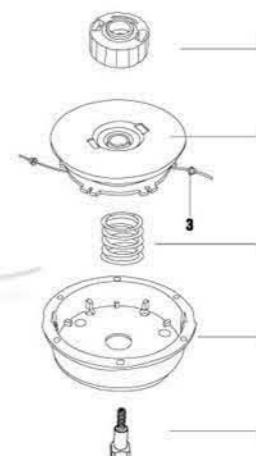

### Spare parts

1	5050121	Knob
2	5050122	Spool without line
3	5050123	Line retainer
4	5050124	Spring
5	5050125	Housing
6	5050126	Adaptor M 8x1.25 Left male
	5050127	Adaptor M 10x1.00 Left female (fits ST only)
	5050128	Adaptor M 10x1.25 Left female
	5050129	Adaptor M 10x1.25 Left male
	5050130	Adaptor M 10x1.50 Left male (fits MC only)
	5050131	Adaptor M 10x1.50 Left female (fits HU only)
	5050132	Adaptor M 12x1.50 Left female
	5050133	Adaptor M 12x1.75 Left female (fits HU only)

STANDARD PACKING: SLEEVE  
Q.TY PER CARTON: 40 PIECES

## TAP-N-GO TRIMMER HEAD 270014

Heavy-duty, tap-d-go string trimmer head. A metal insert in the nylon tap knob extends the head's life by reducing wear and abrasion to the nylon. The tap knob also has a "stay-on" spring, so users never have to crawl around in the grass looking for a spring that popped out. Two split spools make refilling easy and reduce the chance of twining or welding. The eyelet through which the line is threaded is made of aluminum for longer life, and it is replaceable for easy servicing and lower operating costs.



### Spare parts

1	5080111	Upper cover
2	5080112	Spool without line
3	5080113	Line retainer
4	5080114	Spring
	5080115	Adaptor M 8x1.25 Left female
	5080116	Adaptor M 8x1.25 Left male
	5080117	Adaptor M 10x1.00 Left female (fits ST only)
	5080118	Adaptor M 10x1.25 Left female
	5080119	Adaptor M 10x1.25 Left male
	5080120	Adaptor M 10x1.50 Left male (fits MC only)
	5080121	Adaptor M 10x1.50 Left female (fits HU only)
	5080122	Adaptor M 12x1.50 Left female
	5080123	Adaptor M 12x1.75 Left female (fits HU only)
6	5080125	Housing

STANDARD PACKING: SLEEVE  
Q.TY PER CARTON: 40 PIECES

## UNIVERSAL TAP-N-GO TRIMMER HEAD 270017

>> Semi-automatic head "pro universal". Tape-n-go double line head, universal mounting without adaptor, centering bore for both 20+25.4 mm  $\pm$ 0.4 mm nylon line.

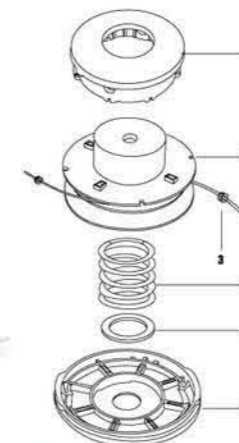

### Spare parts

1	5081212	Housing
2	5081213	Spool without line
3	5081214	Line retainer
4	5081215	Spring
5	5081216	Washer
6	5081217	Upper cover



## MINI TRIMMER HEAD 270018

UNIVERSAL 2-LINE "BUMP-N-GO" TRIMMER HEAD  
Fits Homelite, Ryobi, MTD and McCulloch. Include 5/16" R.H. and L.H. thread and 1/4" R.H. thread knobs, Dual line.



### P/N DESCRIPTION

1 5080131	Knob-Right Hand Thread 5/16" for Homelite, Ryobi
5080132	Knob-Left Hand Thread 5/16" for Homelite, Ryobi
5080133	Knob-Right Hand Thread 1/4" for Homelite, Ryobi MTD, McCulloch.
5080134	Knob-Right Hand Thread 8x1.25
5080135	Knob-Left Hand Thread 8x1.25
5080136	Knob-Right Hand Thread 6x1.0

## EASYLoad TAP-N-GO TRIMMER HEAD Ø120 270019

Semi-automatic head "pro universal", Tap-n-go double line head, universal mounting without adaptor, Line spool with zinc plated still insert. Extreme wear resistance.

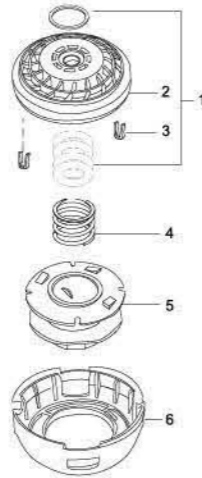
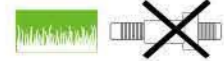

### HIGHLIGHTS

Easy line refilling without disassembling any part of the trimmer head.



1. Insert line from the one eyelet the opposite one.  
2. Turn the knob.  
3. Pull the line on both ends.

### UNIVERSAL Mounting

#### Spare parts

1 50719600	Kit of adaptor washers and reduction rings
2 50719601	Under cover
3 50719602	Line retainer
4 50719603	Spring
5 50719604	Spool without line
6 50719605	Housing

## EASYLoad TAP-N-GO TRIMMER HEAD Ø120 270020

Semi-automatic head "pro universal", Tap-n-go double line head, universal mounting without adaptor, Line spool with zinc plated still insert. Extreme wear resistance.

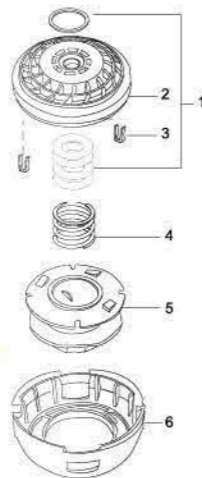

### HIGHLIGHTS

Easy line refilling without disassembling any part of the trimmer head.



1. Insert line from the one eyelet the opposite one.  
2. Turn the knob.  
3. Pull the line on both ends.

### UNIVERSAL Mounting

#### Spare parts

1 50719606	Kit of adaptor washers and reduction rings
2 50719607	Under cover
3 50719608	Line retainer
4 50719609	Spring
5 50719610	Spool without line
6 50719611	Housing

## EASYLoad tap-n-go trimmer head

### TAP-N-GO TRIMMER HEAD 270021

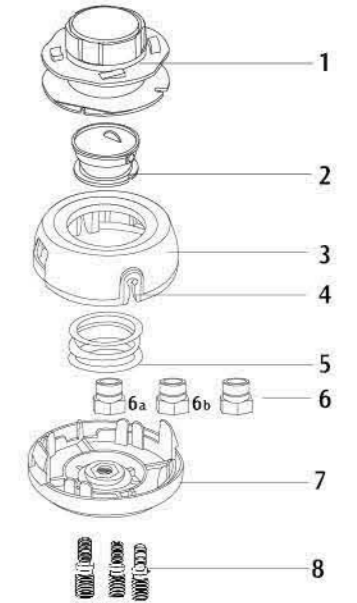

### HIGHLIGHTS

Easy line refilling without disassembling any part of the trimmer head.



1. Insert line from the one eyelet to the opposite one.  
2. Turn the knob.  
3. Pull the line on both ends.



• Heavy duty metal knob. Strong and bumps resistant



• Heavy duty nylon knob. Strong and bumps resistant

### Spare parts

1 5090121	Spool LH
2 5090122	Core
3 5090123	Housing
4 5090124	Eyelet
5 5090125	Spring
6 5090126	Bushing 8 mm x 1.25 LH
6a 5090127	Bushing 10mm x 1.0 LH
6b 5090128	Bushing 10 mm x 1.25 LH
7 5090129	Cover
8 5090130	Stud 7mm x 1.0 LH
8a 5090131	Stud 8mm x 1.25 LH
8b 5090132	Stud 10mm x 1.25 LH
9 5090133	Spacer ø8mm
9a 5090134	Spacer ø10mm

### TAP-N-GO TRIMMER HEAD 270022

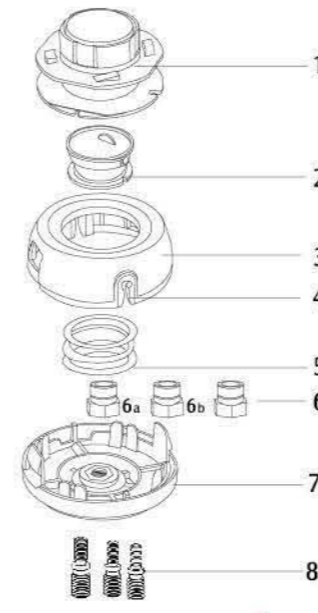

## SPEED-FEED TRIMMER HEAD



# STOP THE FRUSTRATION!

## TAP-N-GO TRIMMER HEAD 270023

Line tensioning system with split spool reduces head vibration.

Ø 4"



Large durable eyelets enhance line life.

Trimmer head is pre-wound with .095 inch (2.4mm) Helicoidal trimmer line.

## TAP-N-GO TRIMMER HEAD 270024

Line tensioning system with split spool reduces head vibration.

Ø 5"

Smooth and durable, the large bottom cover taps on ground to advance line and allows head to glide while trimming



Fits most straight shaft trimmers and brushcutters.

### RELOAD TRIMMER LINE IN 3 EASY STEPS



**Step 1:** Align arrow on knob with eyelet.



**Step 2:** Feed approximately 12' of trimmer line through eyelet.



**Step 3:** Reload by simply turning large knob on top of trimmer head and cutting line to equal lengths.

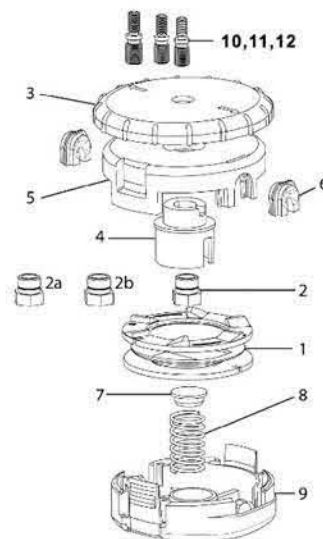

### PRODUCT INFORMATION

PART NUMBER	DESCRIPTION
55-265	Speed-Feed Trimmer Head with bolts for 7MM LH, 8MM LH, 10MM LH

### REPLACEMENT PARTS

NO.	PART NUMBER	DESCRIPTION	QTY.
1	55-348	Spool LH	1
2	55-287	Bushing 10 mm x 1.25 LH	1
2a	55-288	Bushing 10 mm x 1.0 LH	1
2b	55-289	Bushing 8 mm x 1.25 LH	1
3	55-346	Knob	1
4	55-295	Core	1
5	55-347	Eyelet Carrier	1
6	55-336	Eyelet	2
7	55-339	Cap	1
8	55-344	Spring	1
9	55-349	Cover	1
10	55-337	Stud 7mm x 1.0 LH	1
11	55-338	Stud 8mm x 1.25 LH	1
12	55-340	Stud 10mm x 1.25 LH	1

## UNIVERSAL AUTO MATIC FEED TRIMMER HEAD 270025

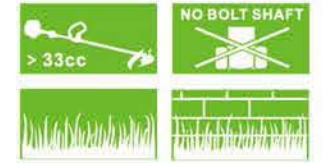
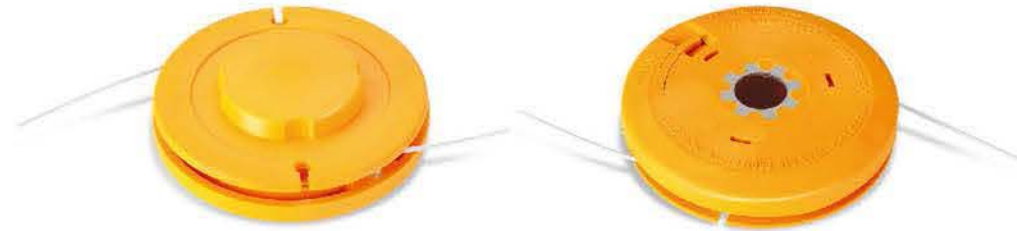

## TAP-N-GO TRIMMER HEAD 270026

Double line, for cutting and thinning. The nylon line is fed by tapping the cutting head on the ground. Comes standard on many trimmers. Adaptor bolts available to fit most of brush cutter, and detail is following:

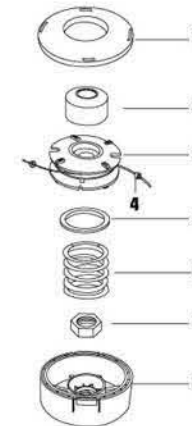

### Spare parts

1	5072101	Upper cover
2	5072102	Top cover
3	5072103	Spool without line
4	5072124	Line retainer
5	5072105	Plate
6	5072106	Spring
7	5072107	Adaptor M 8x1.25 Left female
	5072108	Adaptor M 8x1.25 Left male
	5072109	Adaptor M 10x1.25 Left female
	5072110	Adaptor M 10x1.25 Left male
	5072111	Adaptor M 10x1.50 Left female
	5072112	Adaptor M 12x1.50 Left female
	5072113	Adaptor M 12x1.75 Left female
8	5072114	Housing

STANDARD PACKING: SLEEVE  
Q.TY PER CARTON: 36 PIECES

## TAP-N-GO TRIMMER HEAD 270027

Popular, Semi-automatic ("Tap-n-go") Dual-line head, fits universal curved shaft brush cutter.

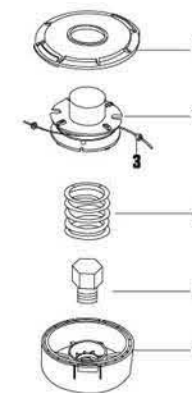

### Spare parts

1	5072211	Upper cover
2	5072212	Spool without line
3	5072213	Line retainer
4	5072214	Spring
5	5072215	Adaptor M 8x1.25 right male
6	5072216	Housing

STANDARD PACKING: SLEEVE  
Q.TY PER CARTON: 36 PIECES



## TAP-N-GO TRIMMER HEAD 270028

Double line, for cutting and thinning. The nylon line is fed by tapping the cutting head on the ground. Comes standard on many trimmers. Adaptor bolts available to fit most of brush cutter, and detail is following:

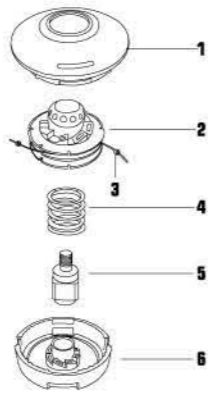

### Spare parts

1	5072115	Upper cover
2	5072116	Spool without line
3	5072117	Line retainer
4	5072118	Spring
5	5072119	Adaptor M 10x1.25 Left female
6	5072120	Adaptor M 12x1.75 Left female
	5072121	Housing
		STANDARD PACKING: SLEEVE
		Q.TY PER CARTON: 40 PIECES



## TAP-N-GO TRIMMER HEAD 270031

Semi-automatic head "pro universal", Tap-n-go double line head, universal mounting without adapter, Line spool with zink plated still insert. Extreme wear resistance. Spool can load 6 meters of round nylon line Ø 2.0mm for professional users.



Ø 109

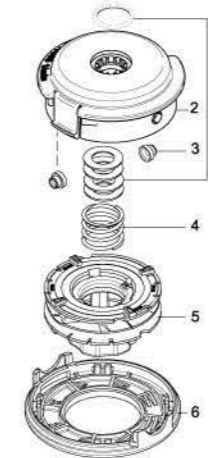

### Spare parts

1	50719030	Kit of adaptor washers and reduction rings
2	50719031	Housing
3	50719032	Line retainer
4	50719033	Spring
5	50719034	Spool without line
6	50719035	Upper cover

## EASYLoad TAP-N-GO TRIMMER HEAD

Double line, for cutting and thinning. The nylon line is fed by tapping the cutting head on the ground. Comes standard on many trimmers. Adaptor bolts available to fit most of brush cutter, and detail is following:

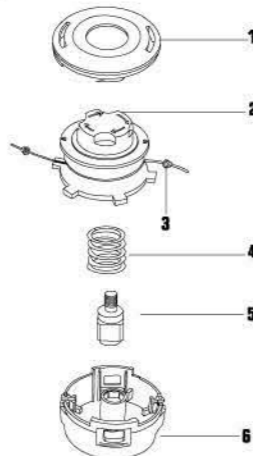

270029

### Spare parts

1	5072901	Upper cover
2	5072902	Spool without line
3	5072903	Line retainer
4	5072904	Spring
5	5072905	Adaptor M 10x1.00 Left female (fits ST only)
6	5072906	Adaptor M 10x1.25 Left female
	5072907	Housing
	5072908	STANDARD PACKING: SLEEVE
		Q.TY PER CARTON: 40 PIECES



Dot and arrow in one line. Inserts line through eyelet. Turn the knob.

## EASYLoad TAP-N-GO TRIMMER HEAD Ø109

Double line nylon head Ø109 mm complete with adaptor bolt.

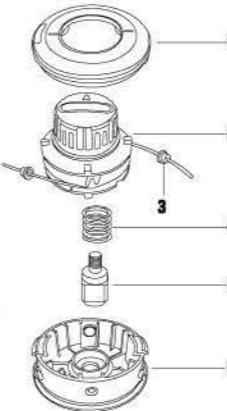

270032

### highlights

► Easy line refilling without disassembling any part of the trimmer head.



### Spare parts

1	8081601	Upper cover
2	8081602	Spool without line
3	8081603	Line retainer
4	8081604	Spring
5	8081605	Adaptor M 8x1.25 Left female
	8081606	Adaptor M 8x1.25 Left male
	8081607	Adaptor M 10x1.25 Left female
	8081608	Adaptor M 10x1.25 Left male
	8081609	Adaptor M 10x1.50 Left female
	8081610	Adaptor M 12x1.50 Left female
	8081611	Adaptor M 12x1.75 Left female
6	8081612	Housing
		STANDARD PACKING: SLEEVE
		Q.TY PER CARTON: 40 PIECES

## TAP-N-GO TRIMMER HEAD 270030

Double line nylon head Ø 109 mm complete with adaptor bolt - Ø 2 mm nylon line.



Ø 109



### Spare parts

1	50719013	Housing
2	50719014	Adaptor M 8x1.25 Left male (fits EMAK only)
	50719015	Adaptor M 8x1.25 Left female
	50719016	Adaptor M 8x1.25 Left male
	50719017	Adaptor M 8x1.25 Right male
	50719018	Adaptor M 10x1.00 Left female (fits ST only)
	50719019	Adaptor M 10x1.25 Left female
	50719020	Adaptor M 10x1.25 Left female (fits HU only)
	50719021	Adaptor M 10x1.25 Left male
	50719022	Adaptor M 10x1.50 Left female (fits HU only)
	50719023	Adaptor M 12x1.50 Left female
	50719024	Adaptor M 12x1.75 Left female (fits HU only)
3	50719026	Spring
4	50719027	Spool without line
5	50719028	Line retainer
6	50719029	Upper cover

## EASYLoad UNIVERSAL TAP-N-GO TRIMMER HEAD Ø109

Double line nylon head Ø109 mm complete with adaptor bolt.

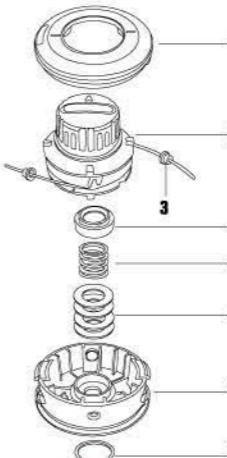

270033

### highlights

► Easy line refilling without disassembling any part of the trimmer head.



### Spare parts

1	50729130	Upper cover
2	50729131	Spool without line
3	50729132	Line retainer
4	50729133	Core
5	50729134	Spring
6	50729135	Kit of adaptor washers and reduction rings
7	50729136	Housing

## EASYLoad TAP-N-GO TRIMMER HEAD Ø130

Double line nylon head Ø130 mm complete with adaptor bolt. **270034**

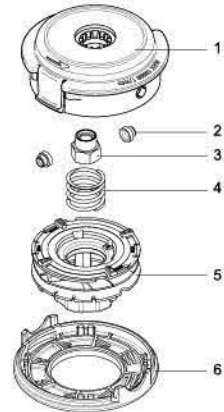

### highlights

► Easy line refilling without disassembling any part of the trimmer head.



#### Spare parts

1	50719036	Housing
2	50719037	Line retainer
3	50719038	Adaptor M 8x1.25 Left male (Fits EMAX only)
	50719039	Adaptor M 8x1.25 Left female
	50719040	Adaptor M 8x1.25 Left male
	50719041	Adaptor M 10x1.00 Left female (fits ST only)
	50719042	Adaptor M 10x1.25 Left female
	50719043	Adaptor M 10x1.25 Left female (fits HU only)
	50719044	Adaptor M 10x1.25 Left male
	50719045	Adaptor M 10x1.50 Left female (fits HU only)
	50719046	Adaptor M 12x1.50 Left female
	50719047	Adaptor M 12x1.75 Left female (fits HU only)
	50719048	Adaptor M 14x1.50 Left female (fits ST only)
4	50719049	Spring
5	50719050	Spool without line
6	50719051	Upper cover



## EASYLoad TAP-N-GO TRIMMER HEAD Ø130

**270035**

Semi-automatic head "pro universal", Tap-n-go double line head, universal mounting without adaptor, Line spool with zink plated still insert. Extreme wear resistance.

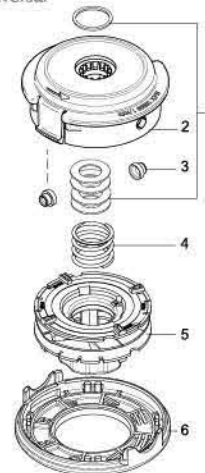

### highlights

► Easy line refilling without disassembling any part of the trimmer head.



#### UNIVERSAL Mounting

#### Spare parts

1	50719052	Kit of adaptor washers and reduction rings
2	50719053	Housing
3	50719054	Line retainer
4	50719055	Spring
5	50719056	Spool without line
6	50719057	Upper cover

## EASYLoad TAP-N-GO TRIMMER HEAD Ø130

Double line nylon head Ø130 mm complete with adaptor bolt. **270036**

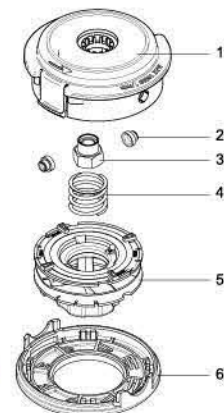

### highlights

► Easy line refilling without disassembling any part of the trimmer head.



#### Spare parts

1	50719058	Housing
2	50719059	Line retainer
3	50719060	Adaptor M 8x1.25 Left male (Fits EMAX only)
	50719061	Adaptor M 8x1.25 Left female
	50719062	Adaptor M 8x1.25 Left male
	50719063	Adaptor M 10x1.00 Left female (fits ST only)
	50719064	Adaptor M 10x1.25 Left female
	50719065	Adaptor M 10x1.25 Left female (fits HU only)
	50719066	Adaptor M 10x1.25 Left male
	50719067	Adaptor M 10x1.50 Left female (fits HU only)
	50719068	Adaptor M 12x1.50 Left female
	50719069	Adaptor M 12x1.75 Left female (fits HU only)
	50719070	Adaptor M 14x1.50 Left female (fits ST only)
4	50719071	Spring
5	50719072	Spool without line
6	50719073	Upper cover

## EASYLoad TAP-N-GO TRIMMER HEAD Ø130

Semi-automatic head "pro universal", Tap-n-go double line head, universal mounting without adaptor, Line spool with zink plated still insert. Extreme wear resistance. **270037**

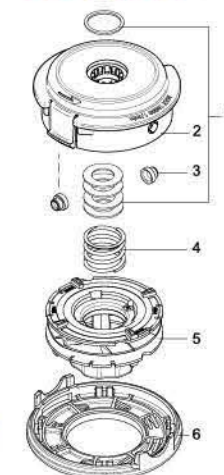
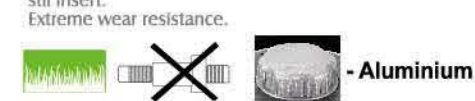

### highlights

► Easy line refilling without disassembling any part of the trimmer head.



#### UNIVERSAL Mounting

#### Spare parts

1	50719074	Kit of adaptor washers and reduction rings
2	50719075	Housing
3	50719076	Line retainer
4	50719077	Spring
5	50719078	Spool without line
6	50719079	Upper cover

## TAP-N-GO TRIMMER HEAD **270038**

Double line, for cutting and thinning. The nylon line is fed by tapping the cutting head on the ground. Comes standard on many trimmers. Adaptor bolts available to fit most of brush cutter, and detail is following:

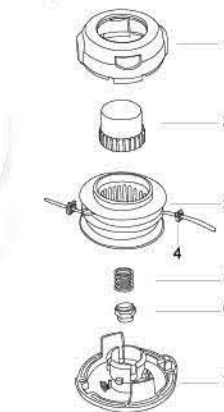

#### Spare parts

1	50719080	Upper cover
2	50719081	Top cover
3	50719082	Spool without line
4	50719083	Line retainer
5	50719084	Spring
6	50719085	Adaptor M 8x1.25 Left female
	50719086	Adaptor M 8x1.25 Left male
	50719087	Adaptor M 10x1.00 Left female
	50719088	Adaptor M 10x1.25 Left female
	50719089	Adaptor M 10x1.25 Left male
	50719090	Adaptor M 10x1.50 Left male
	50719091	Adaptor M 10x1.50 Left female
	50719092	Adaptor M 12x1.50 Left female
	50719093	Adaptor M 12x1.75 Left female
7	50719094	Under cover



## TAP-N-GO TRIMMER HEAD **270039**

Double line, for cutting and thinning. The nylon line is fed by tapping the cutting head on the ground. Comes standard on many trimmers. Adaptor bolts available to fit most of brush cutter, and detail is following:

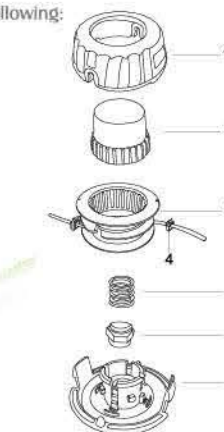

#### Spare parts

1	50719180	Housing
2	50719181	Top cover
3	50719182	Spool without line
4	50719183	Line retainer
5	50719184	Spring
6	50719185	Adaptor M 8x1.25 Left female
	50719186	Adaptor M 8x1.25 Right female
	50719187	Adaptor M 8x1.25 Left male
	50719188	Adaptor M 10x1.00 Left female
	50719189	Adaptor M 10x1.25 Left female
	50719190	Adaptor M 10x1.25 Left male
	50719191	Adaptor M 10x1.50 Left male
	50719192	Adaptor M 10x1.50 Left female
	50719193	Adaptor M 12x1.50 Left female
	50719194	Adaptor M 12x1.75 Left female
7	50719195	Under cover



## TAP-N-GO TRIMMER HEAD 270040

Double line, for cutting and thinning. The nylon line is fed by tapping the cutting head on the ground. Comes standard on many trimmers. Adaptor bolts available to fit most of brush cutter, and detail is following:



**Spare parts**

1	50719612	Upper cover
2	50719613	Top cover
3	50719614	Spool without line
4	50719615	Line retainer
5	50719616	Spring
6	50719617	Adaptor M 8x1.25 Left female
	50719618	Adaptor M 8x1.25 Left male
	50719619	Adaptor M 10x1.00 Left female
	50719620	Adaptor M 10x1.25 Left female
	50719621	Adaptor M 10x1.25 Left male
	50719622	Adaptor M 10x1.50 Left male
	50719623	Adaptor M 10x1.50 Left female
	50719624	Adaptor M 12x1.50 Left female
	50719625	Adaptor M 12x1.75 Left female
7	50719626	Under cover



## TAP-N-GO TRIMMER HEAD 270043

Double line, for cutting and thinning. The nylon line is fed by tapping the cutting head on the ground. Comes standard on many trimmers. Adaptor bolts available to fit most of brush cutter, and detail is following:



**Spare parts**

1	50729296	Housing
2	50729297	Top cover
3	50729298	Bearing
4	50729299	Spool without line
5	50729200	Line retainer
6	50729201	Spring
7	50729202	Adaptor M 8x1.25 Left female
	50729203	Adaptor M 8x1.25 Left male
	50729204	Adaptor M 10x1.00 Left female
	50729205	Adaptor M 10x1.25 Left female
	50729206	Adaptor M 10x1.25 Left male
	50729207	Adaptor M 10x1.50 Left male
	50729208	Adaptor M 10x1.50 Left female
	50729209	Adaptor M 12x1.50 Left female
	50729210	Adaptor M 12x1.75 Left female
8	50729212	Under cover



## MANUAL TRIMMER HEAD 270041

- \* Manual Trimmer Head
- \* Line Is Fed By The User
- \* Achieve The Desired Effect
- \* 2.4 - 2.7mm Suitable Line Dimensions
- \* Push Line Feed Button And Pull Cor



**Spare parts**

1	50719627	Under cover
2	50719628	Adaptor M 8x1.25 Left female
	50719629	Adaptor M 8x1.25 Left male
	50719630	Adaptor M 10x1.00 Left female
	50719631	Adaptor M 10x1.25 Left female
	50719632	Adaptor M 10x1.25 Left male
	50719633	Adaptor M 10x1.50 Left male
	50719634	Adaptor M 10x1.50 Left female
	50719635	Adaptor M 12x1.50 Left female
	50719636	Adaptor M 12x1.75 Left female
3	50719637	Spring
4	50719638	Spool without line
5	50719639	Line retainer
6	50719640	Housing



## HEAVY DUTY Chain trimmer Head 270044



New! Applicable on every type of brushcutter for the crushing, the deforestation and cut of grass and small shrubs and large cut. It occurs however optimal performances for particularly heavy and professional jobs.

**Spare parts**

1	5060101	body
2	5060102	ring
3	5060103	chain
4	5060104	press board
5	5060105	screw
6	5060106	pin
7	5060107	pin cap

## TAP-N-GO TRIMMER HEAD 270042

Double line, for cutting and thinning. The nylon line is fed by tapping the cutting head on the ground. Comes standard on many trimmers. Adaptor bolts available to fit most of brush cutter, and detail is following:



**Spare parts**

1	50729096	Housing
2	50729097	Top cover
3	50729098	Bearing
4	50729099	Spool without line
5	50729100	Line retainer
6	50729101	Spring
7	50729102	Adaptor M 8x1.25 Left female
	50729103	Adaptor M 8x1.25 Left male
	50729104	Adaptor M 10x1.00 Left female
	50729105	Adaptor M 10x1.25 Left female
	50729106	Adaptor M 10x1.25 Left male
	50729107	Adaptor M 10x1.50 Left male
	50729108	Adaptor M 10x1.50 Left female
	50729109	Adaptor M 12x1.50 Left female
	50729110	Adaptor M 12x1.75 Left female
8	50729112	Under cover



## Chain saw blade 9 inch 270045



**FEATUER**

- Designed for fast and easy cutting of small trees, heavy brush, thick weeds and grass.
- Suitable for petrol powered trimmers and brushcutters with engines 30cc and above.
- Also designed to be used on circular saws to cut through wood, linoleum, fibreglass, plexiglass etc.
- Designed to operate at maximum 10,000 RPM.
- Chain repair kits available.
- Comes attractively packaged in durable plastic hanging sleeve.

PART NO.	DESCRIPTION	CHAIN PITCH
5003010	9" Blade	3/8"
5003011	Blade Repair Kit to suit 5003010	3/8"
5003012	25.4 mm - 20 mm reducer washer to suit 5003010 and 5003010 blades	

## TAP-N-GO TRIMMER HEAD 270046

Double line, for cutting and thinning. The nylon line is fed by tapping the cutting head on the ground. Comes standard on many trimmers. Adaptor bolts available to fit most of brush cutter, and detail is following:

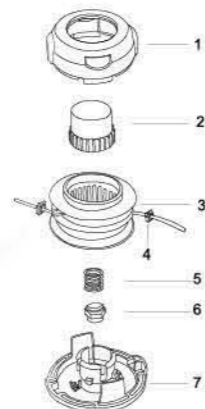

### Spare parts

1	50719296	Upper cover
2	50719297	Top cover
3	50719298	Spool without line
4	50719299	Line retainer
5	50719200	Spring
6	50719201	Adaptor M 8x1.25 Left female
	50719202	Adaptor M 8x1.25 Left male
	50719203	Adaptor M 10x1.00 Left female
	50719204	Adaptor M 10x1.25 Left female
	50719205	Adaptor M 10x1.25 Left male
	50719206	Adaptor M 10x1.50 Left female
	50719207	Adaptor M 10x1.50 Left male
	50719208	Adaptor M 12x1.50 Left female
	50719209	Adaptor M 12x1.75 Left female
7	50719210	Under cover



## HEAVY DUTY TAP-N-GO TRIMMER HEAD 270049

Stihl Autocut 40-4 strimmer/brushcutter head - This is a "tap and go", four line strimmer head for light vegetation. The strimmer line is automatically extended when the mowing head is tapped on the ground. This strimmer head comes loaded with 2.7mm line.

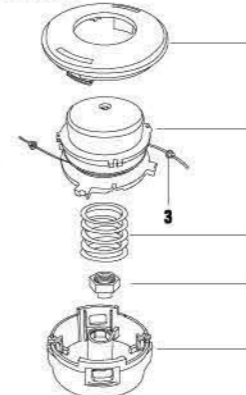

Ø160mm

### Spare parts

1	5072901	Upper cover
2	5072902	Spool without line
3	5072903	Line retainer
4	5072904	Spring
5	5072905	Adaptor M 10x1.00 Left female (fits ST only)
	5072906	Adaptor M 10x1.25 Left female
	5072907	Adaptor M 12x1.75 Left female
	5072908	Adaptor M 14x1.50 Left female (fits ST only)
6	5072909	Housing
		STANDARD PACKING: SLEEVE
		Q.TY PER CARTON: 40 PIECES

## TAP-N-GO TRIMMER HEAD 270047

Double line, for cutting and thinning. The nylon line is fed by tapping the cutting head on the ground. Comes standard on many trimmers. Adaptor bolts available to fit most of brush cutter, and detail is following:



### Spare parts

1	50729196	Housing
2	50729197	Top cover
3	50729198	Bearing
4	50729199	Spool without line
5	50729110	Line retainer
6	50729111	Spring
7	50729112	Adaptor M 8x1.25 Left female
	50729113	Adaptor M 8x1.25 Left male
	50729114	Adaptor M 10x1.00 Left female
	50729115	Adaptor M 10x1.25 Left female
	50729116	Adaptor M 10x1.25 Left male
	50729117	Adaptor M 10x1.50 Left male
	50729118	Adaptor M 10x1.50 Left female
	50729119	Adaptor M 12x1.50 Left female
	50729120	Adaptor M 12x1.75 Left female
8	50729121	Under cover



## HEAVY DUTY TAP-N-GO TRIMMER HEAD 270050

Stihl Autocut 40-2 strimmer/brushcutter head - This is a "tap and go", four line strimmer head for light vegetation. The strimmer line is automatically extended when the mowing head is tapped on the ground. This strimmer head comes loaded with 2.7mm line.



Ø160mm

### Spare parts

1	5073901	Upper cover
2	5073902	Spool without line
3	5073903	Line retainer
4	5073904	Spring
5	5073905	Adaptor M 10x1.00 Left female (fits ST only)
	5073906	Adaptor M 10x1.25 Left female
	5073907	Adaptor M 12x1.75 Left female
	5073908	Adaptor M 14x1.50 Left female (fits ST only)
6	5073909	Housing

## TAP-N-GO TRIMMER HEAD 270048

Double line, for cutting and thinning. The nylon line is fed by tapping the cutting head on the ground. Comes standard on many trimmers. Adaptor bolts available to fit most of brush cutter, and detail is following:



### Spare parts

1	50729396	Housing
2	50729397	Top cover
3	50729398	Bearing
4	50729399	Spool without line
5	50729300	Line retainer
6	50729301	Spring
7	50729302	Adaptor M 8x1.25 Left female
	50729303	Adaptor M 8x1.25 Left male
	50729304	Adaptor M 10x1.00 Left female
	50729305	Adaptor M 10x1.25 Left female
	50729306	Adaptor M 10x1.25 Left male
	50729307	Adaptor M 10x1.50 Left male
	50729308	Adaptor M 10x1.50 Left female
	50729309	Adaptor M 12x1.50 Left female
	50729310	Adaptor M 12x1.75 Left female
8	50729311	Under cover



## TAP-N-GO TRIMMER HEAD 270051

Double line, for cutting and thinning. The nylon line is fed by tapping the cutting head on the ground. Comes standard on many trimmers. Adaptor bolts available to fit most of brush cutter, and detail is following:

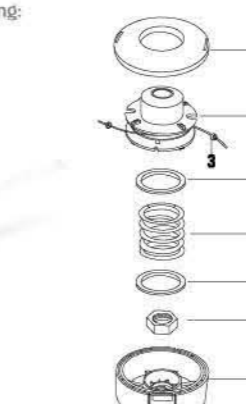

### Spare parts

1	6070101	Upper cover
2	6070102	Spool without line
3	6070103	Line retainer
4	6070104	Plate
5	6070105	Spring
6	6070106	Adaptor M 8x1.25 Left female
	6070107	Adaptor M 8x1.25 Left male
	6070108	Adaptor M 10x1.25 Left female
	6070109	Adaptor M 10x1.25 Left male
	6070110	Adaptor M 10x1.50 Left female
	6070111	Adaptor M 12x1.50 Left female
	6070112	Adaptor M 12x1.75 Left female
7	6070113	Housing
		STANDARD PACKING: SLEEVE
		Q.TY PER CARTON: 40 PIECES

## EASYLoad TAP-N-GO TRIMMER HEAD

Double line nylon head complete with adaptor bolt

**270052**



### highlights

► Easy line refilling without disassembling any part of the trimmer head.

**Spare parts**

1	60739296	Housing
2	60739297	Line retainer
3	60739298	Adaptor M 8x1.25 Left male (Fits EMAK only)
	60739299	Adaptor M 8x1.25 Left female
	60739200	Adaptor M 8x1.25 Left male
	60739201	Adaptor M 10x1.00 Left female (fits ST only)
	60739202	Adaptor M 10x1.25 Left female
	60739203	Adaptor M 10x1.25 Left female (fits HU only)
	60739204	Adaptor M 10x1.25 Left male
	60739205	Adaptor M 10x1.50 Left female (fits HU only)
	60739206	Adaptor M 12x1.50 Left female
	60739207	Adaptor M 12x1.75 Left female (fits HU only)
	60739208	Adaptor M 14x1.50 Left female (fits ST only)
4	60739209	Spring
5	60739210	Spool without line
6	60739211	Upper cover

## EASYLoad TAP-N-GO TRIMMER HEAD

Double line nylon head complete with adaptor bolt

**270053**



### highlights

► Easy line refilling without disassembling any part of the trimmer head.

**Spare parts**

1	60749296	Housing
2	60749297	Line retainer
3	60749298	Adaptor M 8x1.25 Left male (Fits EMAK only)
	60749299	Adaptor M 8x1.25 Left female
	60749200	Adaptor M 8x1.25 Left male
	60749201	Adaptor M 10x1.00 Left female (fits ST only)
	60749202	Adaptor M 10x1.25 Left female
	60749203	Adaptor M 10x1.25 Left female (fits HU only)
	60749204	Adaptor M 10x1.25 Left male
	60749205	Adaptor M 10x1.50 Left female (fits HU only)
	60749206	Adaptor M 12x1.50 Left female
	60749207	Adaptor M 12x1.75 Left female (fits HU only)
	60749208	Adaptor M 14x1.50 Left female (fits ST only)
4	60749209	Spring
5	60749210	Spool without line
6	60749211	Upper cover

## EASYLoad TAP-N-GO TRIMMER HEAD

Double line, for cutting and thinning. The nylon line is fed by tapping the cutting head on the ground. Comes standard on many trimmers. Adaptor bolts available to fit most of brush cutter, and detail is following:

**270054**



### Spare parts

1	6072901	Upper cover
2	6072902	Spool without line
3	6072903	Line retainer
4	6072904	Spring
5	6072905	Adaptor M 8x1.25 Left female
	6072906	Adaptor M 8x1.25 Left male
	6072907	Adaptor M 10x1.0 Left female
	6072908	Adaptor M 10x1.25 Left female
	6072909	Adaptor M 10x1.25 Left male
6	6072910	Housing

## EASYLoad MINI TRIMMER HEAD

UNIVERSAL 2-LINE "BUMP-N-GO" TRIMMER HEAD Fits Homelite, Ryobi, MTD AND McCulloch. INCLUDE 5/16" R.H. and L.H. thread and 1/4" R.H. threa knobs, Dual lien.

**270055**

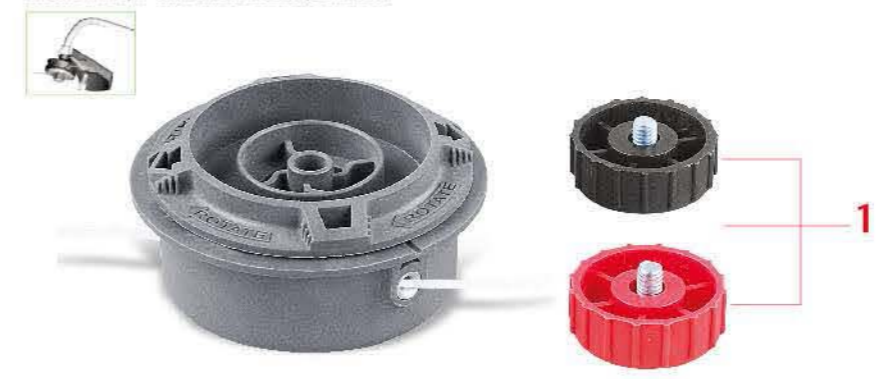

**P/N DE DESCRIPTION**

1	6080131	Knob-Left hand Thread 5/16" for Homelite, Ryobi
	6080132	Knob-Left hand Thread 8x1.25

## TAP-N-GO TRIMMER HEAD

Double line, for cutting and thinning. The nylon line is fed by tapping the cutting head on the ground. Comes standard on many trimmers. Adaptor bolts available to fit most of brush cutter, and detail is following:

**270056**



### Spare parts

1	8080301	Aluminum knob
2	8080302	Upper cover
3	8080303	Spool without line
4	8080304	Line retainer
5	8080305	Spring
6	8080306	Adaptor M 8x1.25 Left female
	8080307	Adaptor M 8x1.25 Left male
	8080308	Adaptor M 10x1.25 Left female
	8080309	Adaptor M 10x1.25 Left male
	8080310	Adaptor M 10x1.50 Left female
	8080311	Adaptor M 12x1.50 Left female
	8080312	Adaptor M 12x1.75 Left female
7	8080313	Housing

STANDARD PACKING: SLEEVE  
Q.TY PER CARTON: 40 PIECES

## TAP-N-GO TRIMMER HEAD

Double line, for cutting and thinning. The nylon line is fed by tapping the cutting head on the ground. Comes standard on many trimmers. Adaptor bolts available to fit most of brush cutter - and detail is followin

**270057**



### Spare parts

1	8080401	Upper cover
2	8080402	Knob
3	8080403	bearing
4	8080404	Gear
5	8080405	Spool without line
6	8080406	Line retainer
7	8080407	Spring
8	8080408	Adaptor M 8x1.25 Left female
	8080409	Adaptor M 8x1.25 Left male
	8080410	Adaptor M 10x1.25 Left female
	8080411	Adaptor M 10x1.25 Left male
	8080412	Adaptor M 10x1.50 Left female
	8080413	Adaptor M 12x1.50 Left female
	8080414	Adaptor M 12x1.75 Left female
9	8080415	Housing

STANDARD PACKING: SLEEVE  
Q.TY PER CARTON: 40 PIECES

## TAP-N-GO TRIMMER HEAD 270058

Double line, for cutting and thinning. The nylon line is fed by tapping the cutting head on the ground. Comes standard on many trimmers. Adaptor bolts available to fit most of brush cutter, and detail is following:



### Spare parts

1	6090121	Upper cover
2	6090122	Line retainer
3	6090123	Spring
4	6090125	Housing
5	6090124	Adaptor M 8x1.25 Left mal(Fits EMAK only)
	6090126	Adaptor M 8x1.25 Left female
	6090127	Adaptor M 8x1.25 Left male
	6090128	Adaptor M 10x1.0 Left female(fits ST only)
	6090129	Adaptor M 10x1.25 Left female
	6090130	Adaptor M 10x1.25 Left female(fits HU only)
	6090131	Adaptor M 10x1.25 Left male
	6090132	Adaptor M 10x1.50 Left female(fits HU only)
	6090133	Adaptor M 12x1.50 Left female
	6090134	Adaptor M 12x1.75 Left female(fits HU only)
	6090135	Adaptor M 14x1.50 Left female(fits ST only)

## MANUAL TRIMMER HEAD 270061

Double line, for cutting and thinning. The nylon line is fed by tapping the cutting head on the ground. Comes standard on many trimmers. Adaptor bolts available to fit most of brush cutter, and detail is following:



### Spare parts

1	8080701	Knob
2	8080702	Spring
3	8080703	Spool without line
4	8080704	Line retainer
5	8080705	Housing
6	8080706	Adaptor M 8x1.25 Left female
	8080707	Adaptor M 8x1.25 Left male
	8080708	Adaptor M 10x1.25 Left female
	8080709	Adaptor M 10x1.25 Left male
	8080710	Adaptor M 10x1.50 Left female
	8080711	Adaptor M 12x1.50 Left female
	8080712	Adaptor M 12x1.75 Left female
		STANDARD PACKING: SLEEVE
		Q.TY PER CARTON: 40 PIECES

## TAP-N-GO TRIMMER HEAD 270059

Double line, for cutting and thinning. The nylon line is fed by tapping the cutting head on the ground. Comes standard on many trimmers. Adaptor bolts available to fit most of brush cutter, and detail is following:



### Spare parts

1	8080501	Knob
2	8080502	Upper cover
3	8080503	Spool without line
4	8080504	Line retainer
5	8080505	Spring
6	8080506	Screw
7	8080507	Housing
8	8080508	Adaptor M 8x1.25 Left female
	8080509	Adaptor M 8x1.25 Left male
	8080510	Adaptor M 10x1.25 Left female
	8080511	Adaptor M 10x1.25 Left male
	8080512	Adaptor M 10x1.50 Left female
	8080513	Adaptor M 12x1.50 Left female
	8080514	Adaptor M 12x1.75 Left female
		STANDARD PACKING: SLEEVE
		Q.TY PER CARTON: 40 PIECES

## TAP-N-GO TRIMMER HEAD 270062

Double line, for cutting and thinning. The nylon line is fed by tapping the cutting head on the ground. Comes standard on many trimmers. Adaptor bolts available to fit most of brush cutter, and detail is following:



### Spare parts

1	8080801	Upper cover
2	8080802	Spool without line
3	8080803	Line retainer
4	8080804	Spring
5	8080805	Adaptor M 8x1.25 Left female
	8080806	Adaptor M 8x1.25 Left male
	8080807	Adaptor M 10x1.25 Left female
	8080808	Adaptor M 10x1.25 Left male
	8080809	Adaptor M 10x1.50 Left female
	8080810	Adaptor M 12x1.50 Left female
	8080811	Adaptor M 12x1.75 Left female
6	8080812	Housing
		STANDARD PACKING: SLEEVE
		Q.TY PER CARTON: 40 PIECES

## TAP-N-GO TRIMMER HEAD 270060

Double line, for cutting and thinning. The nylon line is fed by tapping the cutting head on the ground. Comes standard on many trimmers. Adaptor bolts available to fit most of brush cutter, and detail is following:



### Spare parts

1	8080601	Upper cover
2	8080602	Top cover
3	8080603	Spool without line
4	8080604	Line retainer
5	8080605	Core
6	8080606	Spring
7	8080607	Plate
8	8080608	Adaptor M 8x1.25 Left female
	8080609	Adaptor M 8x1.25 Left male
	8080610	Adaptor M 10x1.25 Left female
	8080611	Adaptor M 10x1.25 Left male
	8080612	Adaptor M 10x1.50 Left female
	8080613	Adaptor M 12x1.50 Left female
	8080614	Adaptor M 12x1.75 Left female
9	8080615	Housing
		STANDARD PACKING: SLEEVE
		Q.TY PER CARTON: 40 PIECES

## TAP-N-GO TRIMMER HEAD 270063

Double line, for cutting and thinning. The nylon line is fed by tapping the cutting head on the ground. Comes standard on many trimmers. Adaptor bolts available to fit most of brush cutter, and detail is following:



### Spare parts

1	8080901	Upper cover
2	8080902	Knob
3	8080903	Bearing
4	8080904	Spool without line
5	8080905	Line retainer
6	8080906	Spring
7	8080907	Adaptor M 8x1.25 Left female
	8080908	Adaptor M 8x1.25 Left male
	8080909	Adaptor M 10x1.25 Left female
	8080910	Adaptor M 10x1.25 Left male
	8080911	Adaptor M 10x1.50 Left female
	8080912	Adaptor M 12x1.50 Left female
	8080913	Adaptor M 12x1.75 Left female
8	8080914	Housing
		STANDARD PACKING: SLEEVE
		Q.TY PER CARTON: 40 PIECES

## EASYLoad TAP-N-GO TRIMMER HEAD 270064

Double line, for cutting and thinning. The nylon line is fed by tapping the cutting head on the ground. Comes standard on many trimmers.

Adaptor bolts available to fit most of brush cutter, and detail is following:



**NEW**



### Spare parts

1	8081001	Upper cover
2	8081002	Knob
3	8081003	Bearing
4	8081004	Spool without line
5	8081005	Line retainer
6	8081006	Core
7	8081007	Spring
8	8081008	Housing
9	8081009	Adaptor M 8x1.25 Left female
	8081010	Adaptor M 8x1.25 Left male
	8081011	Adaptor M 10x1.25 Left female
	8081012	Adaptor M 10x1.25 Left male
	8081013	Adaptor M 10x1.50 Left female
	8081014	Adaptor M 12x1.50 Left female
	8081015	Adaptor M 12x1.75 Left female
		STANDARD PACKING: SLEEVE
		Q.TY PER CARTON: 40 PIECES

## ELECTRIC TRIMMER HEAD 270067

Double line, for cutting and thinning. The nylon line is fed by tapping the cutting head on the ground. Comes standard on many trimmers.



Adaptor bolts available to fit most of brush cutter, and detail is following:



**NEW**



### Spare parts

1	8081301	Upper cover
2	8081302	Spool without line
3	8081303	Line retainer
4	8081304	Core
5	8081305	Spring
6	8081306	Housing

## EASYLoad TAP-N-GO TRIMMER HEAD 270065

Double line, for cutting and thinning. The nylon line is fed by tapping the cutting head on the ground. Comes standard on many trimmers.

Adaptor bolts available to fit most of brush cutter, and detail is following:



**NEW**

### Spare parts

1	8081101	Upper cover
2	8081102	Spool without line
3	8081103	Line retainer
4	8081104	Core
5	8081105	Spring
6	8081106	Housing
7	8081107	Adaptor M 8x1.25 Left female
	8081108	Adaptor M 8x1.25 Left male
	8081109	Adaptor M 10x1.25 Left female
	8081110	Adaptor M 10x1.25 Left male
	8081111	Adaptor M 10x1.50 Left female
	8081112	Adaptor M 12x1.50 Left female
	8081113	Adaptor M 12x1.75 Left female
		STANDARD PACKING: SLEEVE
		Q.TY PER CARTON: 40 PIECES

## MANUAL TRIMMER HEAD 270068

Double line, for cutting and thinning. The nylon line is fed by tapping the cutting head on the ground. Comes standard on many trimmers.

Adaptor bolts available to fit most of brush cutter, and detail is following:



**NEW**

### Spare parts

1	8081401	Knob
2	8081402	Spring
3	8081403	Spool without line
4	8081404	Line retainer
5	8081405	Housing
6	8081406	Adaptor M 8x1.25 Left female
	8081407	Adaptor M 8x1.25 Left male
	8081408	Adaptor M 10x1.25 Left female
	8081409	Adaptor M 10x1.25 Left male
	8081410	Adaptor M 10x1.50 Left female
	8081411	Adaptor M 12x1.50 Left female
	8081412	Adaptor M 12x1.75 Left female
		STANDARD PACKING: SLEEVE
		Q.TY PER CARTON: 40 PIECES

## TAP-N-GO TRIMMER HEAD 270066

Double line, for cutting and thinning. The nylon line is fed by tapping the cutting head on the ground. Comes standard on many trimmers.

Adaptor bolts available to fit most of brush cutter, and detail is following:



**NEW**

### Spare parts

1	8081201	Upper cover
2	8081202	Spool without line
3	8081203	Line retainer
4	8081204	Spring
5	8081205	Adaptor M 8x1.25 Left female
	8081206	Adaptor M 8x1.25 Left male
	8081207	Adaptor M 10x1.25 Left female
	8081208	Adaptor M 10x1.25 Left male
	8081209	Adaptor M 10x1.50 Left female
	8081210	Adaptor M 12x1.50 Left female
	8081211	Adaptor M 12x1.75 Left female
6	8081212	Housing
		STANDARD PACKING: SLEEVE
		Q.TY PER CARTON: 40 PIECES

## HEAVY DUTY TRIMMER HEAD 270069

Double line, for cutting and thinning. The nylon line is fed by tapping the cutting head on the ground. Comes standard on many trimmers.

Adaptor bolts available to fit most of brush cutter, and detail is following:



**NEW**

### Spare parts

1	8081501	Upper cover
2	8081502	Spool without line
3	8081503	Line retainer
4	8081504	Spring
5	8081505	Adaptor M 8x1.25 Left female
	8081506	Adaptor M 8x1.25 Left male
	8081507	Adaptor M 10x1.25 Left female
	8081508	Adaptor M 10x1.25 Left male
	8081509	Adaptor M 10x1.50 Left female
	8081510	Adaptor M 12x1.50 Left female
	8081511	Adaptor M 12x1.75 Left female
6	8081512	Housing
		STANDARD PACKING: SLEEVE
		Q.TY PER CARTON: 40 PIECES

**PIVOT DESIGN TRIMMER HEAD 270070**

Fits 99% of STRAIGHT SHAFT gas trimmers  
 Easy to load and install  
 Uses .105", .095" line or smaller  
 Up to 8 lines  
 Performs great along chain link,  
 concrete and rocks  
 Designed for professional landscapers



Trimmer line pivots as it cuts, reducing wear and tear to enhance life.

**HEAVY DUTY CHAIN TRIMMER HEAD**

**270071**



New! Applicable on every type of brushcutter for the crushing, the deforestation and cut of grass and small shrubs and large cut. It concurs however optimal performances for particularly heavy and professional jobs.

**Whips trimmer Head 270072**

**Whips trimmer Head 270073**

**Whips trimmer Head 270074**



**Whips trimmer Head 270075**

**Whips trimmer Head 270076**

**Whips trimmer Head 270077**



**Butterfly trimmer head 270078**



**Butterfly trimmer head 270079**



**Whips trimmer Head 270080**



**Whips trimmer Head 270081**



**Whips trimmer Head 270082**



**HEAVY DUTY WHIPS ALUMINIUM TRIMMER HEAD 270083**



**FIXED LINE Whips trimmer Head 270084**



**8PCS FIXED LINE Whips trimmer Head 270085**



**8PCS FIXED LINE HIGH LID Whips trimmer Head 270086**



**FIXED LINE Whips trimmer Head 270087**



**FIXED LINE Whips trimmer Head 270088**



**Nylon FIXED LINE Whips trimmer Head 270089**



**4PCS STEEL FIXED LINE Whips trimmer Head 270090**



**STEEL FIXED LINE Whips trimmer Head 270091**



**STEEL FIXED LINE Whips trimmer Head 270092**



**Whips trimmer Head 270090**



**Electric trimmer head 270091**



**Whips trimmer Head 270092**



**8PCS FIXED LINE Whips trimmer Head 270093**



**8PCS FIXED LINE Whips trimmer Head 270094**



**12PCS FIXED LINE Whips trimmer Head 270095**



**Whips trimmer Head 270096**



**Whips trimmer Head 270097**



**Whips trimmer Head 270098**



**Whips trimmer Head 270099**



**Whips trimmer Head 270100**



**Whips trimmer Head 270101**



metal knob Ø80mm

P/N 5090012



Kit of adaptor washers and reduction rings

P/N K00401008



**Whips trimmer Head 270102**



**Whips trimmer Head 270103**



**Whips trimmer Head 270104**



**Trimmer Head 270105**



**ELECTRIC TRIMMER HEAD 270106**

Double line, for cutting and thinning. The nylon line is fed by tapping the cutting head on the ground. Comes standard on many trimmers. Adaptor bolts available to fit most of brush cutter, and detail is following:

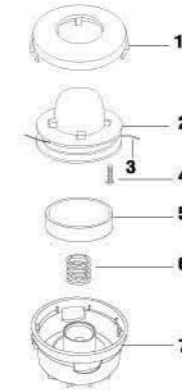

**Spare parts**

1	8081601	Upper cover
2	8081602	Spool without line
3	8081603	Line retainer
4	8081604	Adaptor 7MM
5	8081605	Core
6	8081606	Spring
7	8081607	Housing
		STANDARD PACKING: SLEEVE
		Q.TY PER CARTON: 40 PIECES

**EASY Load TAP-N-GO TRIMMER HEAD C6-2 270107**

Double line, for cutting and thinning. The nylon line is fed by tapping the cutting head on the ground. Comes standard on many trimmers. Adaptor bolts available to fit most of brush cutter, and detail is following:

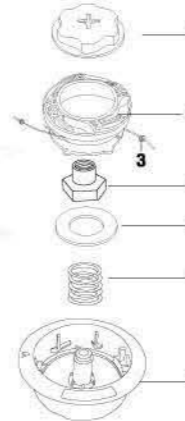

**Spare parts**

1	8081701	Upper cover
2	8081702	Spool without line
3	8081703	Line retainer
4	8081704	Adaptor M 8x1.25 right female
5	8081705	Core
6	8081706	Spring
7	8081707	Housing
		STANDARD PACKING: SLEEVE
		Q.TY PER CARTON: 40 PIECES

**TAP-N-GO TRIMMER HEAD EASY LOAD C26-2 270108**

Double line, for cutting and thinning. The nylon line is fed by tapping the cutting head on the ground. Comes standard on many trimmers. Adaptor bolts available to fit most of brush cutter, and detail is following:

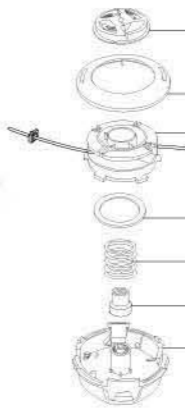

**Spare parts**

1	8081801	Upper cover
2	8081802	Top cover
3	8081803	Spool without line
4	8081804	Line retainer
5	8081813	Washer
6	8081814	Spring
7	8081805	Adaptor M 8x1.25 Left female
	8081806	Adaptor M 8x1.25 Left male
	8081807	Adaptor M 10x1.0 Left female
	8081808	Adaptor M 10x1.25 Left female
	8081809	Adaptor M 10x1.25 Left male
	8081810	Adaptor M 10x1.50 Left male
	8081811	Adaptor M 10x1.50 Left female
	8081812	Adaptor M 12x1.50 Left female
	8081815	Adaptor M 12x1.75 Left female
8	8081816	Housing
		STANDARD PACKING: SLEEVE
		Q.TY PER CARTON: 40 PIECES

## WHIPS ALUMINIUM TRIMMER HEAD



## WHIPS TRIMMER HEAD 270110



## MAGIC AUTO-MATIC FEED LINE TRIMMER HEAD

Double line, for cutting and thinning. The nylon line is fed automatically by the inductor. Comes standard on many trimmers. Adaptor bolts available to fit most of brush cutter, and detail is following: **270112**

### Spare parts

1	8081901	Upper cover
2	8081902	Bolt
3	8081903	Spring
4	8081904	Spool without line
5	8081905	Line retainer
6	8081906	Adaptor M 8x1.25 Left female
	8081907	Adaptor M 8x1.25 Left male
	8081908	Adaptor M 10x1.0 Left female
	8081909	Adaptor M 10x1.25 Left female
	8081910	Adaptor M 10x1.25 Left male
	8081911	Adaptor M 10x1.50 Left male
	8081912	Adaptor M 10x1.50 Left female
	8081913	Adaptor M 12x1.50 Left female
	8081914	Adaptor M 12x1.75 Left female
7	8081915	Housing

STANDARD PACKING: SLEEVE  
Q.TY PER CARTON: 40 PIECES



## EASYLoad TRIMMER HEAD 270113

Double line, for cutting and thinning. The nylon line is fed by tapping the cutting head on the ground. Comes standard on many trimmers. Adaptor bolts available to fit most of brush cutter, and detail is following:

### Spare parts

1	8082001	Triangle knob
2	8082002	Spring
3	8082003	Upper cover
4	8082004	Line retainer
5	8082012	Housing
6	8082005	Adaptor M 8x1.25 Left female
	8082006	Adaptor M 8x1.25 Left male
	8082007	Adaptor M 10x1.0 Left female
	8082008	Adaptor M 10x1.25 Left female
	8082009	Adaptor M 10x1.25 Left male
	8082010	Adaptor M 10x1.50 Left male
	8082011	Adaptor M 10x1.50 Left female
	8082013	Adaptor M 12x1.50 Left female
	8082014	Adaptor M 12x1.75 Left female

STANDARD PACKING: SLEEVE  
Q.TY PER CARTON: 40 PIECES



## MANUAL TRIMMER HEAD 270114

Double line, for cutting and thinning. The nylon line is fed by tapping the cutting head on the ground. Comes standard on many trimmers. Adaptor bolts available to fit most of brush cutter, and detail is following:



### Spare parts

1	8082101	Upper cover
2	8082102	Spool without line
3	8082103	Line retainer
4	8082104	Spring
5	8082105	Housing
6	8082106	Adaptor M 8x1.25 Left female
	8082107	Adaptor M 8x1.25 Left male
	8082108	Adaptor M 10x1.0 Left female
	8082109	Adaptor M 10x1.25 Left female
	8082110	Adaptor M 10x1.25 Left male
	8082111	Adaptor M 10x1.50 Left male
	8082112	Adaptor M 10x1.50 Left female
	8082113	Adaptor M 12x1.5 Left female
	8082114	Adaptor M 12x1.75 Left female

STANDARD PACKING: SLEEVE  
Q.TY PER CARTON: 40 PIECES

## TAP-N-GO TRIMMER HEAD EASY LOAD C26-2 WITH ROUND KNOB 270115

Double line, for cutting and thinning. The nylon line is fed by tapping the cutting head on the ground. Comes standard on many trimmers. Adaptor bolts available to fit most of brush cutter and detail is following:



### Spare parts

1	8082201	Top cover
2	8082202	Upper cover
3	8082203	Spool without line
4	8082204	Line retainer
5	8082205	Washer
6	8082206	Spring
7	8082207	Adaptor M 8x1.25 Left female
	8082208	Adaptor M 8x1.25 Left male
	8082209	Adaptor M 10x1.0 Left female
	8082210	Adaptor M 10x1.25 Left female
	8082211	Adaptor M 10x1.25 Left male
	8082212	Adaptor M 10x1.50 Left male
	8082213	Adaptor M 10x1.50 Left female
	8082214	Adaptor M 12x1.50 Left female
	8082215	Adaptor M 12x1.75 Left female
8	8082216	Housing

STANDARD PACKING: SLEEVE  
Q.TY PER CARTON: 40 PIECES

## EASYLoad TAP-N-GO TRIMMER HEAD 270116

Double line, for cutting and thinning. The nylon line is fed by tapping the cutting head on the ground. Comes standard on many trimmers. Adaptor bolts available to fit most of brush cutter, and detail is following:



### Spare parts

1	8082301	Top cover
2	8082302	Upper cover
3	8082303	Spool without line
4	8082304	Line retainer
5	8082305	Spring
6	8082306	Housing
7	8082307	Adaptor M 8x1.25 Left female
	8082308	Adaptor M 8x1.25 Left male
	8082309	Adaptor M 10x1.0 Left female
	8082310	Adaptor M 10x1.25 Left female
	8082311	Adaptor M 10x1.25 Left male
	8082312	Adaptor M 10x1.50 Left male
	8082313	Adaptor M 10x1.50 Left female
	8082314	Adaptor M 12x1.50 Left female
	8082315	Adaptor M 12x1.75 Left female

STANDARD PACKING: SLEEVE  
Q.TY PER CARTON: 40 PIECES

## MINI TRIMMER HEAD 270117

UNIVERSAL 2-LINE "BUMP-N-GO" TRIMMER HEAD  
Fits Homelite, Ryobi, MTD and McCulloch. Include 5/16" R.H. and L.H. thread and 1/4" R.H. thread knobs. Dual line.



**NEW**

## EASYLoad TAP-N-GO TRIMMER HEAD

Double line, for cutting and thinning. The nylon line is fed automatically by the inductor. Comes standard on many trimmers.

Adaptor bolts available to fit most of brush cutter, and detail is following: **270118**



**NEW**

## EASY LOAD TRIMMER HEAD 270119

Double line, for cutting and thinning. The nylon line is fed by tapping the cutting head on the ground. Comes standard on many trimmers.

Adaptor bolts available to fit most of brush cutter, and detail is following:



**NEW**

### Spare parts

1	8082416	Knob-right Hand Thread 6x1.0
2	8082417	Spool without line
3	8082418	Line retainer
4	8082419	Spring
5	8082420	Housing

STANDARD PACKING: SLEEVE  
Q.TY PER CARTON: 40 PIECES

### Spare parts

1	8082401	Top cover
2	8082402	Upper cover
3	8082403	Spool without line
4	8082404	Line retainer
5	8082405	Spring
6	8082406	Adaptor M 8x1.25 Left female
	8082407	Adaptor M 8x1.25 Left male
	8082408	Adaptor M 10x1.0 Left female
	8082409	Adaptor M 10x1.25 Left female
	8082410	Adaptor M 10x1.25 Left male
	8082411	Adaptor M 10x1.50 Left male
	8082412	Adaptor M 10x1.50 Left female
	8082413	Adaptor M 12x1.50 Left female
	8082414	Adaptor M 12x1.75 Left female
7	8082415	Housing

STANDARD PACKING: SLEEVE  
Q.TY PER CARTON: 40 PIECES

### PRODUCT INFORMATION

PART NUMBER	DESCRIPTION
56-265	Speed-Feed Trimmer Head with bolts for 7MM LH, 8MM LH, 10MM LH

### REPLACEMENT PARTS

NO.	PART NUMBER	DESCRIPTION	QTY.
1	56-348	Spool LH	1
2	56-287	Bushing 10 mm x 1.25 LH	1
2a	56-288	Bushing 10 mm x 1.0 LH	1
2b	56-289	Bushing 8 mm x 1.25 LH	1
3	56-346	Knob	1
4	56-295	Core	1
5	56-347	Eyelet Carrier	1
6	56-336	Eyelet	2
7	56-339	Cap	1
8	56-344	Spring	1
9	56-349	Cover	1
10	56-337	Stud 7mm x 1.0 LH	1
11	56-338	Stud 8mm x 1.25 LH	1
12	56-340	Stud 10mm x 1.25 LH	1

## Guide list for nylon head adaptors

ALKO	LT250C	8 x 1.25 LHM
	MS400, 106146	10 x 1.25 LHF
	106389, 106144, 106436, 106145	8 x 1.25 LHF
BLUEBIRD	SBC23E, 27E, NBC31EA, NBC38E, M47, M54	10 x 1.00 LHF
DOLMAR	BC250, LT250, BC330, BC400, SD330, BC250, PRO370, PRO400, MS3300/4000/4500	10 x 1.25 LHM
	BC337, BC377, NB26, NB03, NB04, NB31, NB40, MS3500, NB40, NB411, NB50, NB351, BD330, C250, LT-250	10 x 1.00 LHF
	BC225, C225, LT225, MS220, MS2300, MS2600, MS3100, LT154, NB, NB01F, NB02, NB16F, NB211, NBF171, NB26/31, LT225, LT255, NB2, NB271, MS-250, MS3200, MS5200, MS2810	8 x 1.25 LHF
	MS340, BC-12, BC-210, BC-212, MS5250, BC210, BC212, MS-30C, MS30U	10 x 1.25 LHF
	MS3300, MS4000, MS4500, MS3310, MS-4010, MS-4510	12 x 1.50 LHF
	NB231AU, NB231A, NB23F, NB171, LT250	8 x 1.25 RHF
	LT210	10 x 1.25 RHF
ECHO	SRM2300L, 2300U, SRM2090L, 2090U, SRM250EL, ARM400A, RM460, RMA2530, SRA2190, 250EU, SRM310, 310U, RM380, SRM302BDX, SRM3800, SRM4600, SRM2450L, 2450U, SRM3500, SRM3550, SRM2510, RM460, SRA2190, RMA2530, SRM2600L, 2600U, SRM3150L, 3150U, SRM343SL, CLS4600, GT2400, RM310, SRM2010L, 140, 160AE, 190, 200, 200BE, 250/EU, 300, 302, 310/U, 400, 402, 500, 501, 3150U, 3800, 4600, SRM300, RMA2530, SRM140DA, SRM1500, SRM1501, SRM200BE, SRM200CE, SRM200DA, SRM200DB, SRM2010, SRM2200, SRM2201, SRM2301, SRM2500, SRM2501, SRM2502, SRM3000, SRM3001, SRM300AE, SRM300E, SRM3010, SRM400AE, SRM400BE, SRM402DE, SRM3800, 2010, 2300, 2090, 2090U, 2510, 3500, 2190, 2530, SRM-2450L, 2500, 2501, 2502, 250EL, 2510, 2600L, 3010, SRM-2455, 2015, 2455, 315SL, 360, 2655, 400, 5000	10 x 1.25 RHF
	ST160AE, 500, 501, 210AE, 2300/U, 2450U, 2510, 2530, 2600U	12 x 1.75 LHF
	CLS4600, CLS5800, CLS5810	7 x 1.00 LHM
HOMELITE	TM523	8 x 1.25 LHM
	BCH - 20, 24 2D, 32C, 33, 33B, 33DI, 33TO	8 x 1.25 LHF
	HBC30, -30B, 38, 40, HK- 14, 18, 24, 28, 33, 38, PCB3600, 3600E, PLT3400, ST155, 175C, 185C, 285C, 385C, ST485, ST485C	8 x 1.25 LHM
	ST360, ST385, SXD20, TK518, NBA524, PMB522, TXD508	10 x 1.25 LHF
	BCH38, BCH40, BCH48, PBC3800, PBC4000	10 x 125 LHM
	NBA524, PMB522, TXD508	8 x 1.25 LHM
HONDA	UH41, SXD-25HE	10 x 1.25 LHF
	UMK422LTE/UT4E/LT4E	7 x 1.00 LHM
HUSQVARNA	24R (before 1987)	12 x 1.75 LHM
	265RX, 250RX, 245RX, 135R, 132RD, 132LD, 125R, 25R, 125RD, 125LD, 125RB, 132RL, 245R, 125L, 132L, 125RJ, 125RJD, 26R, 235R, 32L, 120L, 225L, 225LD, 227R	10 x 1.25 LHF
	232L, 232LCAT, 32R, 225RJ, 225R, RD, 232R, 232RCAT, 322L, 325LX/XT, 325RJX, 322RJ, 325RX/RXT	12 x 1.75 LHF
	235RCAT, 240R, 240RBD, 250RX, 245R, 245RX, 265RX, 140R, 165R, 244R, 244GX, 36R, 39R, 16R, 18RL, 22RL, 240RJ, 142RB, 152RB, 252RX	3/8" x .24 RHF
	Mondo MEGA, Mondo Maxi	8 x 1.25 LHM
	16R, 25R - before 1987	8 x 1.25 LHM
MC CULLOCH	BP30AV, DELTA, MS33/40, S'MAC30AV, TD2400/3300/4000	8 x 1.25 LHF
	MAC22/23/30/38	8 x 1.25 RHF
	MAC17/25	10 x 1.25 LHF
	100A, 90/A, 95A, 99A, EB3, MAC80/90/95A, PS1/2/3/4/5, SEB4, SM100, SMAC30AV, SMAV38AV	10 x 1.25 LHM
	TD2100, MAC32, MAC37	10 x 1.25 RHF
	MAC60A, MAC80A	10 x 1.50 LHM
	SUPERMAC26, MAC30A, 30AV, PRATER30, EUROPA92/35A, EUROPA, MS24, MS52, PROMAC38AV, BP38AV, WINDSORKIT26, VERSAILLES38, BP26AV, BP35AV	10 x 1.25 LHF
	MAC85A, MAC90A, MAC95A, SMAC30AV, SMAC38AV	8 x 1.25 LHM
MAKITA	RBC230, RBC260, RBC310, RBC410, RBK410, RBC525	12 x 1.50 LHF
	DBC3300, DBC4000, DBC4000C	

# Guide list for nylon head adaptors



<b>MARUNAKA</b>	BC180/181DX, BC200/240DX, TM2/21/24DX/F3L	8 x 1.25 LHF
	BT181DX	8 x 1.25 RHF
	G13K	10 x 1.25 LHF
	BC480DX, G3/5, GL3K, T240DX/F53/L	10 x 1.25 LHM
	TM33DX/F43L, TM33DX/F43, T200DX/F43L, T200DX/F43, TM33JX./F404L, T200JX/F404L, BC330DX, BC400DX, BK404FX	10 x 1.50 LHF
<b>MARUYAMA</b>	BC184/C, BC220DE, BC230/241/326/330/402/480, BC331BK, MB100/250/300/400/500	8 x 1.25 LHM
	32, 35	10 x 1.25 LHM
	23	10 x 1.50 LHF
	BC200C, BC260/H, MC260/S	10 x 1.25 LHF
<b>OLEOMAC</b>	TR60E, TR101E, 720, SPARTA26TR, 725B,	8 x 1.25 LHF
	725BL, 722/726S, SPARTA26S, SPARTA26, 725S/T/D, 730S/T, 735S/T, 740S/T, 746S/T, 733S/T, 755MASTER, 435/440/446/453BP	8 x 1.25 LHM
<b>PARTNER</b>	B400	10 x 1.00 LHF
	200, 203, 205, B250C, B250V(before1987), T250, B323, B325	10 x 1.25 LHF
	B370, B380, B180, B440, B450, B405, B250C/V, B250U, B450G, B450/C, B265J, B405	12 x 1.75 LHF
	T221, T321, B322	8 x 1.00 LHF
<b>POULAN</b>	150, 200, 2620, 800, 900	10 x 1.50 LHF
<b>ROBIN</b>	NB30K, NBR30/40	8 x 1.25 LHM
	IVBK411, NB02, NB16F, NB211, NB26, NB281A, NB31/AU, NB351, NBA231, NBK411, NBT415, IVBF231, NB231, NB23F, NBF171, NBF231	8 x 1.25 LHF
	IVB50L, NB03/4, NB411L, NB50L	10 x 1.00 LHF
<b>RYOBI</b>	180KS/S, 3318, REK285BP	8 x 1.25 LHM
	RD1605, RD2414, RD3818	8 x 1.25 LHF
	RD5224, RD5225, RSB2801, RSH1100	10 x 1.25 LHM
	RD260	10 x 1.50 LHF
	RD330, RD430, RD520	12 x 1.75 LHF
<b>SHINDAIWA</b>	C20/230, LT18/20, T18/20/A, T230/XR, T23E, T35	7 x 1.00 LHM
	BP35/45, C23/25/27, C250, F20, R2025/35F, T25/27/250, T260/270/350, YARDWARE220	8 x 1.25 LHM
	B35/40/45, BP35, C35, RC35/45, F18	10 x 1.25 LHM
<b>STIHL</b>	FS50, FS51, FS60, FS61, FS65, FS80E, FS90AVE	8 x 1.25 LHM
	FS44, FS52, FS56, FS66, FS86, FR106, FS74, FS74R, FE55, FS36, FS88, FR108, FS40, FS76, FS76R, FS106, FS108, FS48, FS52, FS62, FS81, FS96,	10 x 1.00 LHF
	FS160, FS220, FS55/R, FS25-4/R, FS65-4/R, FS80R, FS85/R/RT	10 x 1.50 LHF
	420, FS08, FS150/180, FS20, FS200, FS280/K, FS353AV, FS360, FS410, FS420, FR350/450, FS350/450/400K/450K, FS400/L, FS500, FS550	12 x 1.50 LHF
<b>SOLO</b>	FS125, S200, S300	8 x 1.25 LHF
	123, 125, Multimot	10 x 1.00 LHF
	100, 130S, 014, 119, 400, FS135, FS136, S100, S400	10 x 1.25 LHF
	115, 118	10 x 1.25 RHF
	124, 126, 127, 128, 130, 134, 137, 140, 141	12 x 1.50 LHF
<b>TAS TANAKA</b>	AST250/5000/7000, SUM250, SUM301/321/321E/351/400, SUM421/500/7000, TBC16/160/162/20/2000, SUM205/215/220/2200, TBC225-255, TCB23/232/2507250DH/262/265/265SDH/262, TBC265, TBC265S DH/30/300/322/355/37/373/4000/422/422BDH, TBC4500/500/5000/500DH/501/202, TBC300SDH/355DH, TST218, TUM220, TUM250	8 x 1.25 LHM
	SUM3	10 x 1.25 LHF
	TBC16, AST5000, TBC5000, TBC4000	8 x 1.25 RHF
<b>ZENOAH</b>	BC220DL, BC221DL, BC17, BC23, BC32	7 x 1.00 LHM
	BC2300DL	8 x 1.00 LHF
	BC254A, BC260DM/DUM, BC260DM, BC340DWM/FW, BC341DWH, BC431DWM, BC432FWM, BCD20, BCF01, BK345FL, BK435FL, BK530DL	8 x 1.25 LHM
	BC431FWM, BC531DWM, BC532DWM, BK531DL, FBC22, FBC26	10 x 1.25 LHM

# TRIMMER LINE

A premium nylon line for professional heavy duty.



- Sharper cutting edges for better performance.
- Available in assorted colors.
- Comes in all standards sizes.
- Ideal for all kinds of trimming and edging jobs.
- Designed for the professional landscaper and ed-user.
- Suitable for most leading trimmers and brush cutters.

## Section shape of line

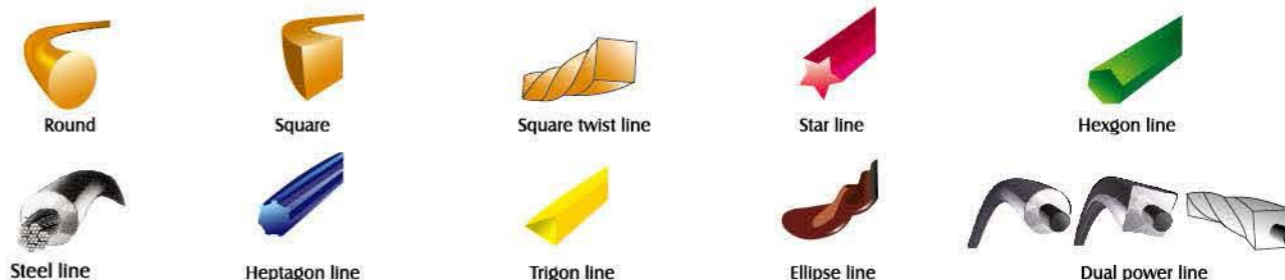

## Colors of line

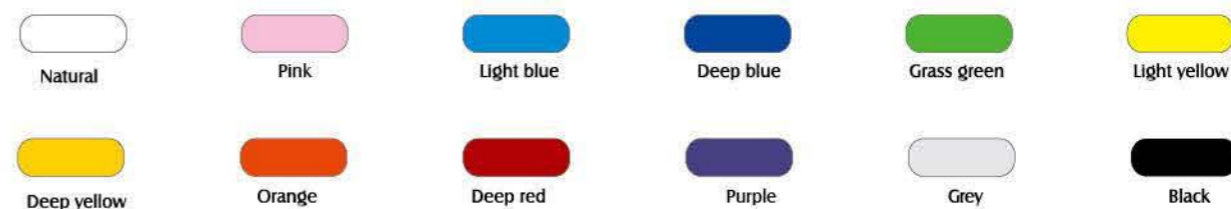

## Shaped cutting performance:

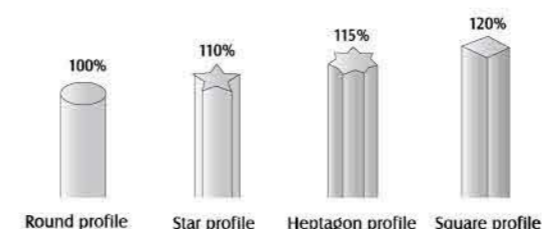

## dB(A) Sound power lever

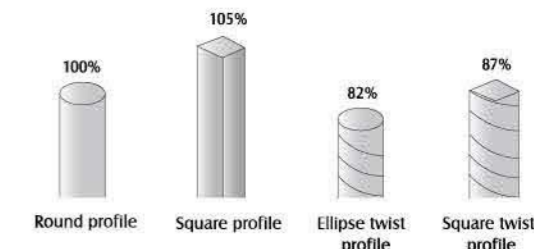

## PRE-CUT LINE

Set of 50 round nylon whips, 300mm(12") long

TYPE



P/N	DESCRIPTION
50719013	∅ 2.4(0.095")x30cm
50719014	∅ 3.0(0.120")x30cm
50719015	∅ 3.3(0.130")x30cm
50719016	∅ 4.0(0.155")x30cm



P/N	DESCRIPTION
50719017	∅ 2.4(0.095")x30cm
50719018	∅ 3.0(0.120")x30cm
50719019	∅ 3.3(0.130")x30cm
50719020	∅ 4.0(0.155")x30cm

**TRIMMER LINE**  
15M Card head package



Round Dou Round

P/N	DESCRIPTION
60719021	∅ 1.3(0.050")x15m
60719022	∅ 1.65(0.065")x15m
60719023	∅ 2.00(0.08")x15m
60719024	∅ 2.40(0.095")x15m
60719025	∅ 2.65(0.105")x15m
60719026	∅ 3.0(0.120")x15m

Square Dou Square

P/N	DESCRIPTION
60719027	∅ 1.3(0.050")x15m
60719028	∅ 1.65(0.065")x15m
60719029	∅ 2.00(0.08")x15m
60719030	∅ 2.40(0.095")x15m
60719031	∅ 2.65(0.105")x15m
60719032	∅ 3.0(0.120")x15m

Square twist Dou square twist

P/N	DESCRIPTION
60719200	∅ 1.3(0.050")x15m
60719201	∅ 1.65(0.065")x15m
60719202	∅ 2.00(0.08")x15m
60719203	∅ 2.40(0.095")x15m
60719204	∅ 2.65(0.105")x15m
60719205	∅ 3.0(0.120")x15m

Star line Dou Star

P/N	DESCRIPTION
60719085	∅ 1.3(0.050")x15m
60719086	∅ 1.65(0.065")x15m
60719087	∅ 2.00(0.08")x15m
60719088	∅ 2.40(0.095")x15m
60719089	∅ 2.65(0.105")x15m
60719090	∅ 3.0(0.120")x15m

Hexgon line

P/N	DESCRIPTION
60719091	∅ 1.3(0.050")x15m
60719092	∅ 1.65(0.065")x15m
60719093	∅ 2.00(0.08")x15m
60719094	∅ 2.40(0.095")x15m
60719095	∅ 2.65(0.105")x15m
60719096	∅ 3.0(0.120")x15m

Heptagon line

P/N	DESCRIPTION
60719097	∅ 1.3(0.050")x15m
60719098	∅ 1.65(0.065")x15m
60719099	∅ 2.00(0.08")x15m
60719100	∅ 2.40(0.095")x15m
60719101	∅ 2.65(0.105")x15m
60719102	∅ 3.0(0.120")x15m

15M Donut Blister package



Round Dou Round

P/N	DESCRIPTION
60719033	∅ 1.3(0.050")x15m
60719034	∅ 1.65(0.065")x15m
60719035	∅ 2.00(0.08")x15m
60719036	∅ 2.40(0.095")x15m
60719037	∅ 2.65(0.105")x15m
60719038	∅ 3.0(0.120")x15m

Square Dou Square

P/N	DESCRIPTION
60719039	∅ 1.3(0.050")x15m
60719040	∅ 1.65(0.065")x15m
60719041	∅ 2.00(0.08")x15m
60719042	∅ 2.40(0.095")x15m
60719043	∅ 2.65(0.105")x15m
60719044	∅ 3.0(0.120")x15m

Square twist Dou square twist

P/N	DESCRIPTION
60719206	∅ 1.3(0.050")x15m
60719207	∅ 1.65(0.065")x15m
60719208	∅ 2.00(0.08")x15m
60719209	∅ 2.40(0.095")x15m
60719210	∅ 2.65(0.105")x15m
60719211	∅ 3.0(0.120")x15m

Star line Dou Star

P/N	DESCRIPTION
60719103	∅ 1.3(0.050")x15m
60719104	∅ 1.65(0.065")x15m
60719105	∅ 2.00(0.08")x15m
60719106	∅ 2.40(0.095")x15m
60719107	∅ 2.65(0.105")x15m
60719108	∅ 3.0(0.120")x15m

Hexgon line

P/N	DESCRIPTION
60719109	∅ 1.3(0.050")x15m
60719110	∅ 1.65(0.065")x15m
60719111	∅ 2.00(0.08")x15m
60719112	∅ 2.40(0.095")x15m
60719113	∅ 2.65(0.105")x15m
60719114	∅ 3.0(0.120")x15m

Heptagon line

P/N	DESCRIPTION
60719115	∅ 1.3(0.050")x15m
60719116	∅ 1.65(0.065")x15m
60719117	∅ 2.00(0.08")x15m
60719118	∅ 2.40(0.095")x15m
60719119	∅ 2.65(0.105")x15m
60719120	∅ 3.0(0.120")x15m

1/2LB Donut Blister package



Round Dou Round

P/N	DESCRIPTION
60719045	∅ 1.3(0.050")x149m
60719046	∅ 1.65(0.065")x92m
60719047	∅ 2.00(0.08")x63m
60719048	∅ 2.40(0.095")x44m
60719049	∅ 2.65(0.105")x36m
60719050	∅ 3.0(0.120")x28m
60719051	∅ 3.30(0.130")x23m

Square Dou Square

P/N	DESCRIPTION
60719052	∅ 2.00(0.08")x57m
60719053	∅ 2.40(0.095")x40m
60719054	∅ 2.65(0.105")x33m
60719055	∅ 3.0(0.120")x25m
60719056	∅ 3.30(0.130")x21m

Square twist Dou square twist

P/N	DESCRIPTION
60719212	∅ 1.65(0.065")x130m
60719213	∅ 2.00(0.08")x83m
60719214	∅ 2.40(0.095")x58m
60719215	∅ 2.65(0.105")x48m
60719216	∅ 3.0(0.120")x37m
60719217	∅ 3.30(0.130")x31m

Star line Dou Star

P/N	DESCRIPTION
60719121	∅ 2.00(0.08")x64m
60719122	∅ 2.40(0.095")x58m
60719123	∅ 2.65(0.105")x48m
60719124	∅ 3.0(0.120")x37m
60719125	∅ 3.30(0.130")x31m

Hexgon line

P/N	DESCRIPTION
60719126	∅ 2.00(0.08")x62m
60719127	∅ 2.40(0.095")x44m
60719128	∅ 2.65(0.105")x36m
60719129	∅ 3.0(0.120")x28m
60719130	∅ 3.30(0.130")x23m

Heptagon line

P/N	DESCRIPTION
60719131	∅ 2.00(0.08")x79m
60719132	∅ 2.40(0.095")x55m
60719134	∅ 2.65(0.105")x45m
60719135	∅ 3.0(0.120")x35m
60719136	∅ 3.30(0.130")x29m

1LB Donut Blister package



Round Dou Round

P/N	DESCRIPTION
60719218	∅ 2.00(0.08")x126m
60719219	∅ 2.40(0.095")x87m
60719220	∅ 2.65(0.105")x72m
60719221	∅ 3.0(0.120")x56m
60719222	∅ 3.30(0.130")x46m

Square Dou Square

P/N	DESCRIPTION
60719223	∅ 2.00(0.08")x117m
60719224	∅ 2.40(0.095")x82m
60719225	∅ 2.65(0.105")x67m
60719226	∅ 3.0(0.120")x52m
60719227	∅ 3.30(0.130")x43m

Square twist Dou square twist

P/N	DESCRIPTION
60719228	∅ 2.00(0.08")x167m
60719229	∅ 2.40(0.095")x116m
60719230	∅ 2.65(0.105")x95m
60719231	∅ 3.0(0.120")x74m
60719232	∅ 3.30(0.130")x62m

Star line Dou Star

P/N	DESCRIPTION
60719233	∅ 2.00(0.08")x167m
60719234	∅ 2.40(0.095")x116m
60719235	∅ 2.65(0.105")x95m
60719236	∅ 3.0(0.120")x74m
60719237	∅ 3.30(0.130")x62m
60719238	∅ 3.50(0.140")x54m
60719239	∅ 4.00(0.155")x42m

Hexgon line

P/N	DESCRIPTION
60719240	∅ 2.00(0.08")x126m
60719241	∅ 2.40(0.095")x87m
60719242	∅ 2.65(0.105")x72m
60719243	∅ 3.0(0.120")x56m
60719244	∅ 3.30(0.130")x46m
60719245	∅ 3.50(0.140")x41m
60719246	∅ 4.00(0.155")x32m

Heptagon line

P/N	DESCRIPTION
60719247	∅ 2.00(0.08")x157m
60719248	∅ 2.40(0.095")x109m
60719249	∅ 2.65(0.105")x90m
60719250	∅ 3.0(0.120")x70m
60719251	∅ 3.30(0.130")x58m
60719252	∅ 3.50(0.140")x51m
60719253	∅ 4.00(0.155")x39m

**TRIMMER LINE**  
1LB Spool profile(0.45kg)



P/N	DESCRIPTION
50719101	∅ 2.00(0.08")x126m
50719102	∅ 2.40(0.095")x87m
50719103	∅ 2.65(0.105")x72m
50719104	∅ 3.0(0.120")x56m
50719105	∅ 3.30(0.130")x46m



P/N	DESCRIPTION
50719106	∅ 2.00(0.08")x117m
50719107	∅ 2.40(0.095")x82m
50719108	∅ 2.65(0.105")x67m
50719109	∅ 3.0(0.120")x52m
50719110	∅ 3.30(0.130")x43m



P/N	DESCRIPTION
50719111	∅ 2.00(0.08")x167m
50719112	∅ 2.40(0.095")x116m
50719113	∅ 2.65(0.105")x95m
50719114	∅ 3.0(0.120")x74m
50719115	∅ 3.30(0.130")x62m



P/N	DESCRIPTION
50719121	∅ 2.00(0.08")x167m
50719122	∅ 2.40(0.095")x116m
50719123	∅ 2.65(0.105")x95m
50719124	∅ 3.0(0.120")x74m
50719125	∅ 3.30(0.130")x62m
50719126	∅ 3.50(0.140")x55m
50719127	∅ 4.00(0.155")x42m



P/N	DESCRIPTION
50719128	∅ 2.00(0.08")x126m
50719129	∅ 2.40(0.095")x87m
50719130	∅ 2.65(0.105")x72m
50719131	∅ 3.0(0.120")x56m
50719132	∅ 3.30(0.130")x46m
50719133	∅ 3.50(0.140")x41m
50719134	∅ 4.00(0.155")x32m



P/N	DESCRIPTION
50719135	∅ 2.00(0.08")x156m
50719136	∅ 2.40(0.095")x109m
50719137	∅ 2.65(0.105")x89m
50719138	∅ 3.0(0.120")x70m
50719139	∅ 3.30(0.130")x58m
50719140	∅ 3.50(0.140")x51m
50719141	∅ 4.00(0.155")x39m

3LB Spool profile(1.35kg)



P/N	DESCRIPTION
50719301	∅ 2.00(0.08")x374m
50719302	∅ 2.40(0.095")x259m
50719303	∅ 2.65(0.105")x213m
50719304	∅ 3.0(0.120")x167m
50719305	∅ 3.30(0.130")x138m



P/N	DESCRIPTION
50719306	∅ 2.00(0.08")x339m
50719307	∅ 2.40(0.095")x236m
50719308	∅ 2.65(0.105")x193m
50719309	∅ 3.0(0.120")x152m
50719310	∅ 3.30(0.130")x125m

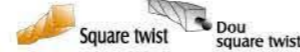

P/N	DESCRIPTION
50719311	∅ 2.00(0.08")x498m
50719312	∅ 2.40(0.095")x346m
50719313	∅ 2.65(0.105")x284m
50719314	∅ 3.0(0.120")x222m
50719315	∅ 3.30(0.130")x184m

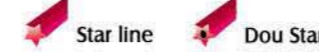

P/N	DESCRIPTION
50719321	∅ 2.00(0.08")x498m
50719322	∅ 2.40(0.095")x346m
50719323	∅ 2.65(0.105")x284m
50719324	∅ 3.0(0.120")x222m
50719325	∅ 3.30(0.130")x184m
50719326	∅ 3.50(0.140")x163m
50719327	∅ 4.00(0.155")x124m



P/N	DESCRIPTION
50719328	∅ 2.00(0.08")x374m
50719329	∅ 2.40(0.095")x259m
50719330	∅ 2.65(0.105")x213m
50719331	∅ 3.0(0.120")x167m
50719332	∅ 3.30(0.130")x138m
50719333	∅ 3.50(0.140")x122m
50719334	∅ 4.00(0.155")x94m



P/N	DESCRIPTION
50719335	∅ 2.00(0.08")x468m
50719336	∅ 2.40(0.095")x325m
50719337	∅ 2.65(0.105")x266m
50719338	∅ 3.0(0.120")x208m
50719339	∅ 3.30(0.130")x172m
50719340	∅ 3.50(0.140")x152m
50719341	∅ 4.00(0.155")x117m

5LB Spool profile(2.25kg)



P/N	DESCRIPTION
50719501	∅ 2.00(0.08")x623m
50719502	∅ 2.40(0.095")x432m
50719503	∅ 2.65(0.105")x355m
50719504	∅ 3.0(0.120")x276m
50719505	∅ 3.30(0.130")x229m



P/N	DESCRIPTION
50719506	∅ 2.00(0.08")x567m
50719507	∅ 2.40(0.095")x394m
50719508	∅ 2.65(0.105")x324m
50719509	∅ 3.0(0.120")x252m
50719510	∅ 3.30(0.130")x209m



P/N	DESCRIPTION
50719511	∅ 2.00(0.08")x830m
50719512	∅ 2.40(0.095")x576m
50719513	∅ 2.65(0.105")x473m
50719514	∅ 3.0(0.120")x369m
50719515	∅ 3.30(0.130")x306m



P/N	DESCRIPTION
50719521	∅ 2.00(0.08")x830m
50719522	∅ 2.40(0.095")x756m
50719523	∅ 2.65(0.105")x474m
50719524	∅ 3.0(0.120")x369m
50719525	∅ 3.30(0.130")x305m
50719526	∅ 3.50(0.140")x272m
50719527	∅ 4.00(0.155")x208m



P/N	DESCRIPTION
50719528	∅ 2.00(0.08")x623m
50719529	∅ 2.40(0.095")x432m
50719530	∅ 2.65(0.105")x355m
50719531	∅ 3.0(0.120")x276m
50719532	∅ 3.30(0.130")x229m
50719533	∅ 3.50(0.140")x204m
50719534	∅ 4.00(0.155")x156m



P/N	DESCRIPTION
50719535	∅ 2.00(0.08")x778m
50719536	∅ 2.40(0.095")x540m
50719537	∅ 2.65(0.105")x443m
50719538	∅ 3.0(0.120")x346m
50719539	∅ 3.30(0.130")x286m
50719540	∅ 3.50(0.140")x254m
50719541	∅ 4.00(0.155")x195m

10LB Spool profile(4.5kg)



P/N	DESCRIPTION
50720001	∅ 2.00(0.08")x1246m
50720002	∅ 2.40(0.095")x856m
50720003	∅ 2.65(0.105")x710m
50720004	∅ 3.0(0.120")x554m
50720005	∅ 3.30(0.130")x458m



P/N	DESCRIPTION
50720006	∅ 2.00(0.08")x1132m
50720007	∅ 2.40(0.095")x758m
50720008	∅ 2.65(0.105")x645m
50720009	∅ 3.0(0.120")x503m
50720010	∅ 3.30(0.130")x416m



P/N	DESCRIPTION
50720011	∅ 2.00(0.08")x1662m
50720012	∅ 2.40(0.095")x1154m
50720013	∅ 2.65(0.105")x946m
50720014	∅ 3.0(0.120")x738m
50720015	∅ 3.30(0.130")x610m



P/N	DESCRIPTION
50720021	∅ 2.00(0.08")x1661m
50720022	∅ 2.40(0.095")x1154m
50720023	∅ 2.65(0.105")x946m
50720024	∅ 3.0(0.120")x738m
50720025	∅ 3.30(0.130")x610m
50720026	∅ 3.50(0.140")x542m
50720027	∅ 4.00(0.155")x416m



P/N	DESCRIPTION
50720028	∅ 2.00(0.08")x1246m
50720029	∅ 2.40(0.095")x956m
50720030	∅ 2.65(0.105")x710m
50720031	∅ 3.0(0.120")x554m
50720032	∅ 3.30(0.130")x458m
50720033	∅ 3.50(0.140")x407m
50720034	∅ 4.00(0.155")x312m



P/N	DESCRIPTION
50720035	∅ 2.00(0.08")x1578m
50720036	∅ 2.40(0.095")x1082m
50720037	∅ 2.65(0.105")x887m
50720038	∅ 3.0(0.120")x692m
50720039	∅ 3.30(0.130")x572m
50720040	∅ 3.50(0.140")x508m
50720041	∅ 4.00(0.155")x389m

15LB,20LB,24LB,30LB.....are all available